

Instructions



AFIS508VSX

Fast Idle System - Work Truck Application

2020 Ford F250-F600 6.7L Diesel engine Only (-BPG)

2024 Ford F650-F750 Diesel engine (-BPG)

2024-2025 Ford E-Series 7.3L Gas engine (-BPG2)

2024 Ford F650-F750 Gas engine (-BPG2)

System Operation

The AFIS508VSX-BPG is a Fast Idle system that elevates engine idle RPM based on a number of “triggers”. The vehicle must be in Park for Fast Idle to engage. When the external Fast Idle input is activated and all safety conditions are met, AFIS508 will increase engine idle speed to 1200 RPM on Diesel Engines and 1500RPM on Gas Engines.

IMPORTANT—READ BEFORE INSTALLATION

It is the installer’s responsibility to route and secure all wiring harnesses where they cannot be damaged by sharp objects, mechanical moving parts and high heat sources. Failure to do so could result in damage to the system or vehicle and create possible safety concerns for the operator and passengers. Avoid placing the module where it could encounter strong magnetic fields from high current cabling connected to motors, solenoids, etc. Avoid radio frequency energy from antennas or inverters next to the module. Avoid high voltage spikes in vehicle wiring by always using diode clamped relays when installing upfitter circuits.

Installation Instructions

Disconnect vehicle battery before proceeding with installation.



WARNING
Disconnect the battery to
prevent setting a check engine
light.

AFIS508VSX-BPG Module

Remove the lower dash panel below the steering column area and find a suitable location to mount the module so that the Diagnostic LED’s can be viewed with the lower dash panel removed. Secure using 2-sided foam tape, screws or wire ties. Locate the module in an area away from any high heat sources. Do not actually mount the module until all wire harnesses are routed and secure. The last step of the installation is to mount the module.

Instructions

Ford 24-Pin "T" Gateway Harness (B-AFIS508VSX-BPG)

1. Locate the vehicles Gateway Module. It will be mounted below the lower left dash panel.
2. Remove the harness behind the Gateway module by pressing the locking tab and pulling outward.
3. Plug the Female side of the Intermotive Gateway Harness into the back of the Gateway module. Ensure the connection is fully seated and secured by the locking tab.
4. Plug the Male side of the Intermotive Data Link Harness into the Gateway harness.
5. Secure the AFIS Gateway harness so that it does not hang below the lower dash panel.

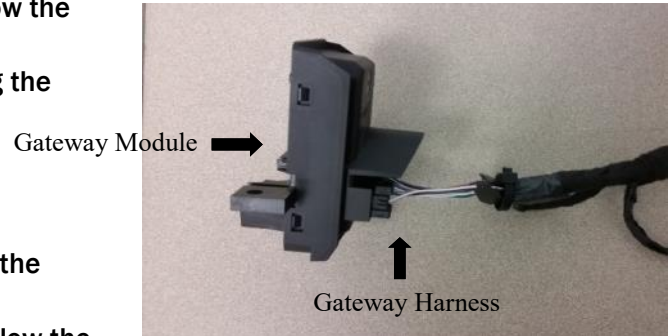

Fast Idle SEIC connections (Diesel Engine Only)

The Ford Super Duty can no longer Fast Idle over the CAN network. Beginning in 2020, the following connections must be made:

1. Locate the Customer Access 22-pin harness located behind the passenger kick panel.
2. The mating 22-pin pigtail is included with the vehicle and will be located in the vehicle's glovebox.
3. Using solder and heat shrink, connect the following wires together:

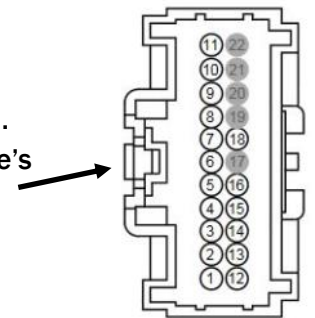

- White wire from the Intermotive harness (840-00058) to the White/Brown wire of the OEM 22-pin pigtail.
- Yellow wire from the Intermotive harness (840-00058) to the Yellow/Green wire of the OEM 22-pin pigtail.
- Green wire from the Intermotive harness (840-00058) to the Green wire of the OEM 22-pin pigtail.

Fast Idle SEIC connections (2024-2025 E-Series Only)

- Locate the Customer Access 16-pin harness (C143) located under the hood.
- Connect the mating 16-pin connector (840-00284) to C143.
- Run the Yellow/Green wire to a pass-through wire that goes through the bulkhead.
- Take the selected passthrough wire on the other side of the bulkhead and connect it to the SEIC output Pin 2 on the AFIS module.
- Plug the terminal on the end of the passthrough wire into the correct pin on the J3 8-pin connector.



Connector C143

Instructions

Fast Idle SEIC connections (2024 F650-F750 Only)

The Ford Super Duty can no longer Fast Idle over the CAN network. Beginning in 2024, the following connections must be made:

1. Locate the Customer Access 16-pin harness located behind the passenger kick panel.
2. The mating 16-pin pigtail is included with the vehicle and will be located in the vehicle's glovebox.
3. Using solder and heat shrink, connect the following wires together:
 - White wire from the Intermotive harness (840-00058) to the Yellow/Gray wire of the OEM 16-pin pigtail.
 - Yellow wire from the Intermotive harness (840-00058) to the Yellow/Green wire of the OEM 16-pin pigtail.
 - Green wire from the Intermotive harness (840-00058) to the Green/Orange wire of the OEM 16-pin pigtail.

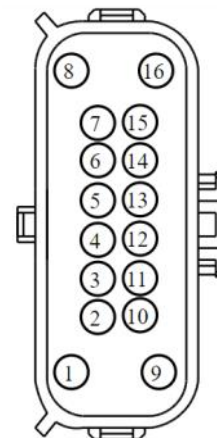

AFIS Harness (8-Pin Connector) Fast Idle Engage Inputs

Engage Input 1

Attach the AFIS Harness connector Pin #8 Green wire to any equipment that provides a ground signal when the fast idle needs to be engaged. (PTO, pump, etc....)

Note: The “sense” of the Green wire can be programmed (see below). This alternatively allows equipment which provides a 12V “active” signal to be connected to this input.

Engage Input 1—Fast Idle Pin-8 Trigger, Active: Ground or 12V signal Enable/Disable

The module is configured from the factory for an active ground fast idle trigger. To change this to an active 12V trigger, the following sequence must be performed:

Turn the key on, place the transmission in neutral, apply the Service Brake, pull out on the Park Brake release and apply the Park Brake four times within 5 seconds.

Upon successful reprogramming, the LEDs will flash as a confirmation. Cycle the key for the change to take affect. Repeat to reverse back to a ground trigger.

VBAT Low Fast Idle Trigger Disable, Black wire loop

The system is configured from the factory for Fast Idle to be triggered when the battery voltage (VBAT) drops below 12.5V. If the VBAT Low Fast Idle Trigger is not desired, it can be disabled by cutting the Black wire loop on the 8-Pin connector between Pin #1 and Pin #3.



Instructions

Post Installation System Operation Test

Perform the following tests before actually mounting the module, to allow easy viewing of the diagnostic LED's, if needed.

1. Place transmission in Park and start the engine. **Note:** Vehicle may enter Fast Idle if VBAT is low. Either wait to see if the battery charges and Fast Idle stops, or place a charger on the vehicle to disable the VBAT low trigger to allow testing of other triggers.
2. One at a time, manually engage all three Fast Idle Inputs by having aftermarket vehicle equipment ground the Input wires. Engine speed will increase to the set RPM level. If this does not occur, check harness connections. Also see diagnostics below.
3. When Fast Idle is engaged, keep the Input wire grounded, and depress the Service Brake for 1 second. Fast idle will temporarily disengage anytime the Service Brake is pressed, and will automatically reengage after approximately 2 seconds once the Brake pedal is released.
4. Place transmission shift lever in the "Neutral" position. (Input wire still grounded). Verify the vehicle does not go into Fast Idle.

If the AFIS508VSX-B fails any of the above tests, check harnesses and review instructions, or check diagnostics below. If necessary, call InterMotive Technical Support at (530) 823-1048.

Diagnostics

Diagnostic mode is entered by momentarily shorting the two gold "Test" pads together on the module. The module provides diagnostic LEDs which illuminate according to the following table. To exit this mode, cycle the key or momentarily ground the "Test" pad again.

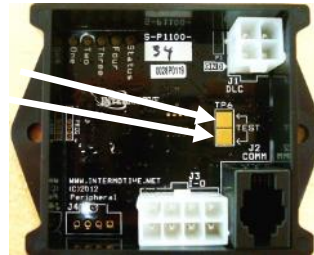

Fast Idle Status Codes

Status Codes provide the current status of the Fast Idle system. The on-board "Status" LED will flash a 2-digit code as shown in the table. The first digit will flash, wait one second, flash the second digit, then wait four seconds before the next code. The Status Codes continue to flash until the module is reset (cycle key), or the test input is momentarily grounded again.

LED #	Diagnostic Mode LED Descriptions
1	On when fast idle is engaged
2	On when any input trigger wire is active
3	On when Gray RPM set wire is grounded
4	On when the Parking Brake is applied with the parking brake trigger enabled
STATUS	Continuously flashes two digit status codes. See Status Code table

AFIS Status Codes	
Status Code	Description
1-1	Ready for fast idle
2-3	Triggered: Parking Brake
2-4	Triggered: VBAT Low
2-8	Triggered: Engage Input 1
3-1	RPM > 2800
3-2	RPM < 200
3-3	TR not = to PARK
3-4	VSS not = to 0 MPH
3-5	Service Brake applied
3-7	Unsafe; Need to cycle TR
3-8	ECT > 230°F

Module Mounting

Ensure all harnesses are properly connected and routed, and are not hanging below the dash area. Mount the AFIS508VSX-BPG module using screws or double sided tape. Reinstall the lower dash panel.

Instructions

LEAVE IN VEHICLE

AFIS508VSX

Fast Idle System - Work Truck Application

2020 Ford F250-F600 6.7L Diesel engine Only (-BPG)

2024 Ford F650-F750 Diesel engine (-BPG)

2024-2025 Ford E-Series 7.3L Gas engine (-BPG2)

2024 Ford F650-F750 Gas engine (-BPG2)

System Operation

The Advanced Fast Idle System (AFIS) elevates engine idle speed in response to a number of “triggers” in order to assist electrical or mechanical systems on the vehicle.

Fast Idle may be initiated by either a manual trigger (Input wire being grounded), or a low battery voltage (low VBAT) condition.

Fast Idle will only occur when the required preconditions are met, as listed below. Fast Idle operation will be terminated by a loss of any of the preconditions, or removal of the trigger(s).

Fast Idle Triggers		
Trigger Name	Trigger Conditions	Disable Conditions
Manual Engage Inputs#1	Fast Idle Engage Input wire(s) activated	Fast Idle Engage Input wires not active
VBAT Low	VBAT < 12.5V	Any Precondition Violation
Parking Brake (if enabled)	Parking Brake applied	Parking Brake Released

Fast Idle Preconditions

- The following preconditions must be met prior to initiating Fast Idle operation:
- Vehicle speed zero
- Transmission in Park
- Accelerator pedal must not be applied
- Engine Coolant temperature less than 230°F
- Engine RPM must be greater than 200 and less than 2800.
- Service Brake not applied

AFIS508VSX-BPG

Input 1: 1200 RPM Diesel

VBAT Low: 12.5V

Parking Brake Trigger: Disabled

AFIS508VSX-BPG2

Input 1: 1500 RPM Gas

VBAT Low: 12.5V

Parking Brake Trigger: Disabled

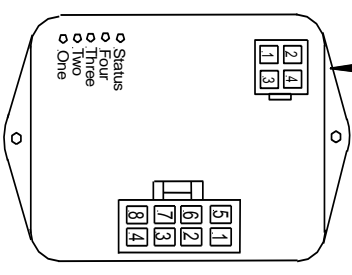
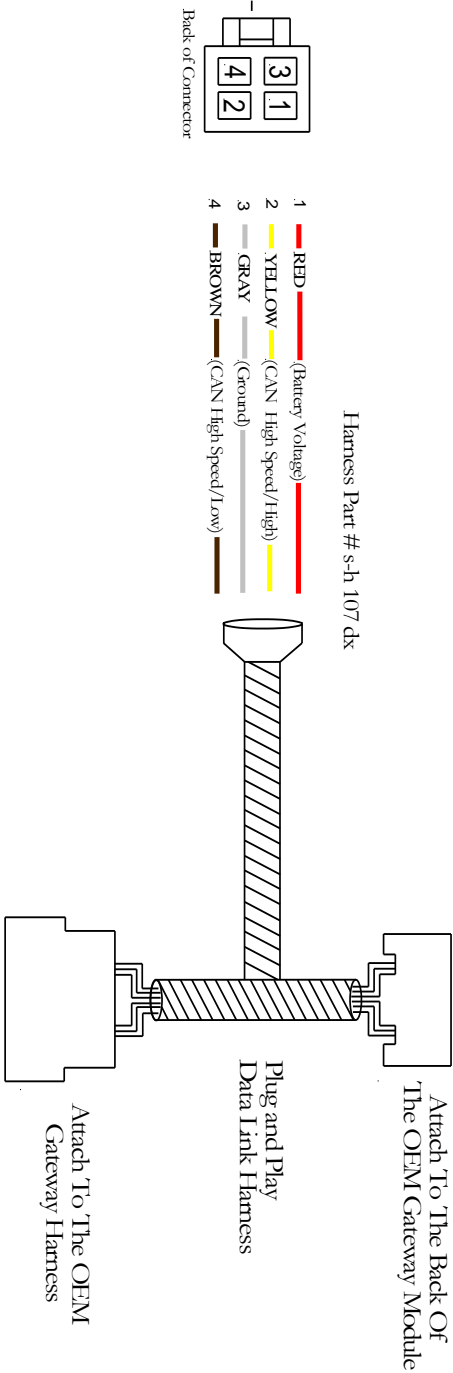

AFIS 508 V/SX-B
Part # 820-1100-004

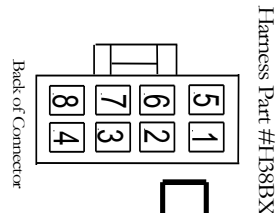

- Harness Part #H38BX
- 1 BLACK
 - 2 YELLOW Fast Idle Output
 - 3 BLACK
 - 4 N/C
 - 5 N/C
 - 6 N/C
 - 7 N/C
 - 8 GREEN

Diesel SEIC harness 840-00058
Gas SEIC harness 840-00248

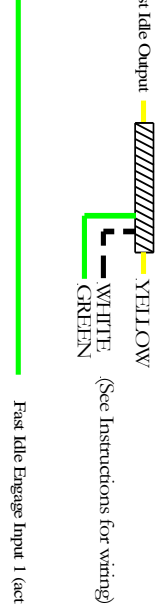

2024-2025 E-Series SEIC Harness



Submit product registration at www.intermotive.net

If the AFIS508 fails any step in the Post Installation Check List, review the installation instructions and check all connections.
If necessary, call Intermotive Technical Support at (530) 823-1048.