

**Gateway**

**INTERMOTIVE**  
**VEHICLE**  
**CONTROLS**

An ISO 9001:2015 Registered Company

# Gateway

## High Idle and Shift Interlock System

### Overview

- All-in-one wheelchair interlock and high idle system to ensure full functionality of the vehicle's systems while using the lift
- Provides battery charge protection and improves air conditioning performance
- System is fully compliant with FMVSS 403/404 and the Americans with Disabilities Act (ADA) for wheelchair lift interlocks
- Simple plug and play connections to the OEM chassis

### Features

- Prevents vehicle movement while the lift is in use by locking the shifter in Park
- Monitors OEM sensor inputs from the transmission, engine, charging system and ambient air temperature
- Programmable RPM for high idle
- Prevents driving with the park brake set
- Can provide real-time chassis data
- Diagnostic trouble codes available
- Uses Intermittent Fault Filter™ (IFF) technology to eliminate erroneous lift door signals

*Product features may vary by make, model or year. See instructions for complete details.*

Proudly distributed by

**LGS GROUP**  
AUTOMOTIVE TECHNOLOGIES

**(775) 831-2002**

# Details

## EXAMPLE SCHEMATIC

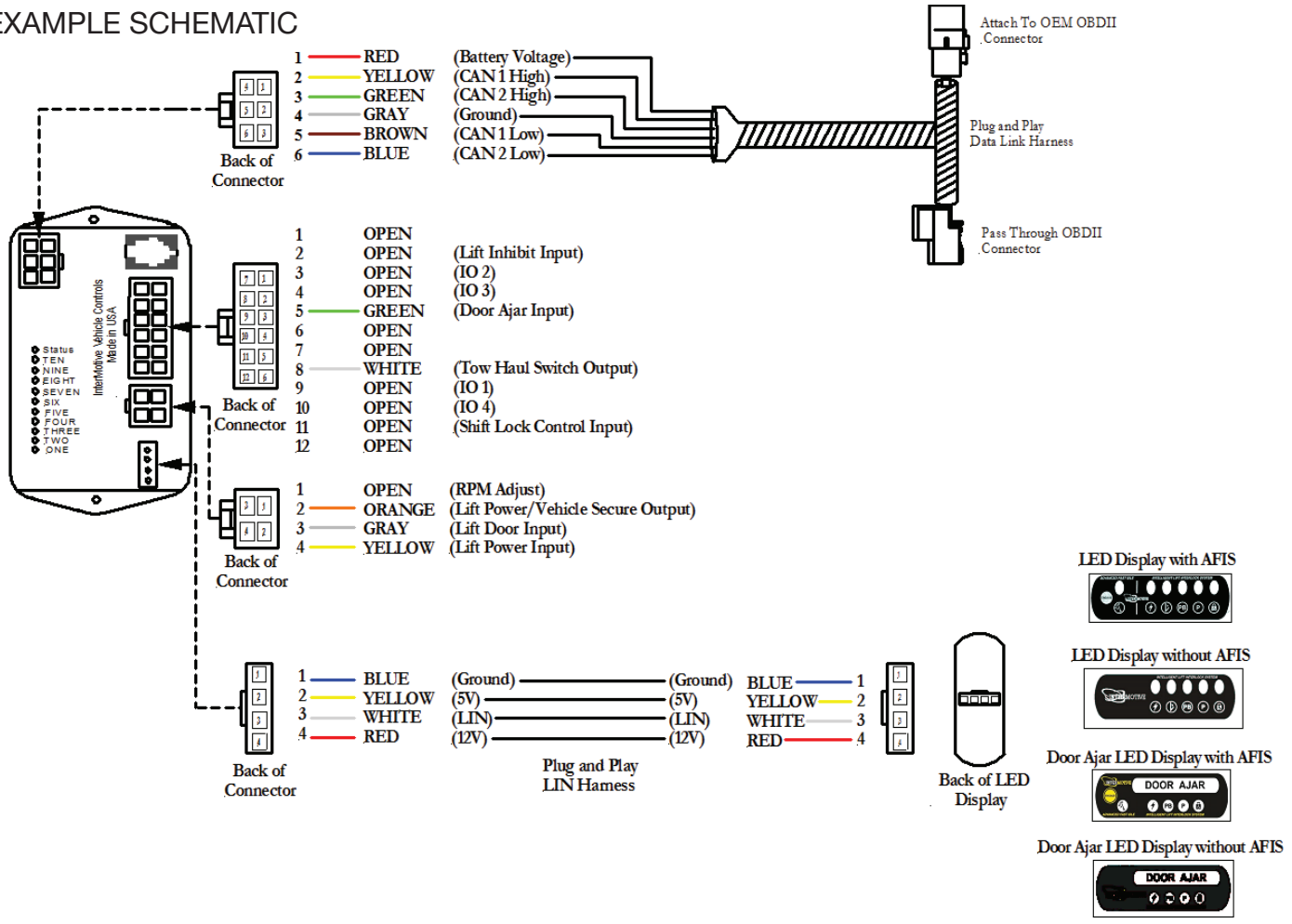

## SPECIFICATIONS

Number of Inputs	Five inputs (lift inhibit, door ajar, shift lock, lift door and RPM adjust)
Number of Outputs	Four configurable outputs, plus one lift power/vehicle secure output and one tow haul switch output
Current Draw	~120 mA
Quiescent Draw	~2 mA (sleep current)
CAN Speed	High and medium speed
Temperature Range	-40°C to 80°C
Dimensions	4" L x 2" W x 1" H