

**EcoStar**

**INTERMOTIVE**  
**VEHICLE**  
**CONTROLS**

An ISO 9001:2015 Registered Company

# EcoStar™

## Idle Reduction System

### Overview

- Automatically turns the engine off and on when specific conditions are met
- Configurable to custom conditions
- Helps meet anti-idling regulations
- Simple plug and play connections

### Features

- **FUEL SAVINGS:** Cuts idling fuel consumption nearly in half; pays for itself in a short period of time
- **ECO-FRIENDLY:** Reduces carbon dioxide emissions and saves 19 lbs per gallon burned while idling
- Thermostat regulation option available to keep interior temperature comfortable for personnel or temperature-sensitive equipment



Ignition switch "T" harness shown

*Product features may vary by make, model or year. See instructions for complete details.*

Proudly distributed by

**LGS GROUP**  
AUTOMOTIVE TECHNOLOGIES

**(775) 831-2002**

# Details

## EXAMPLE SCHEMATIC

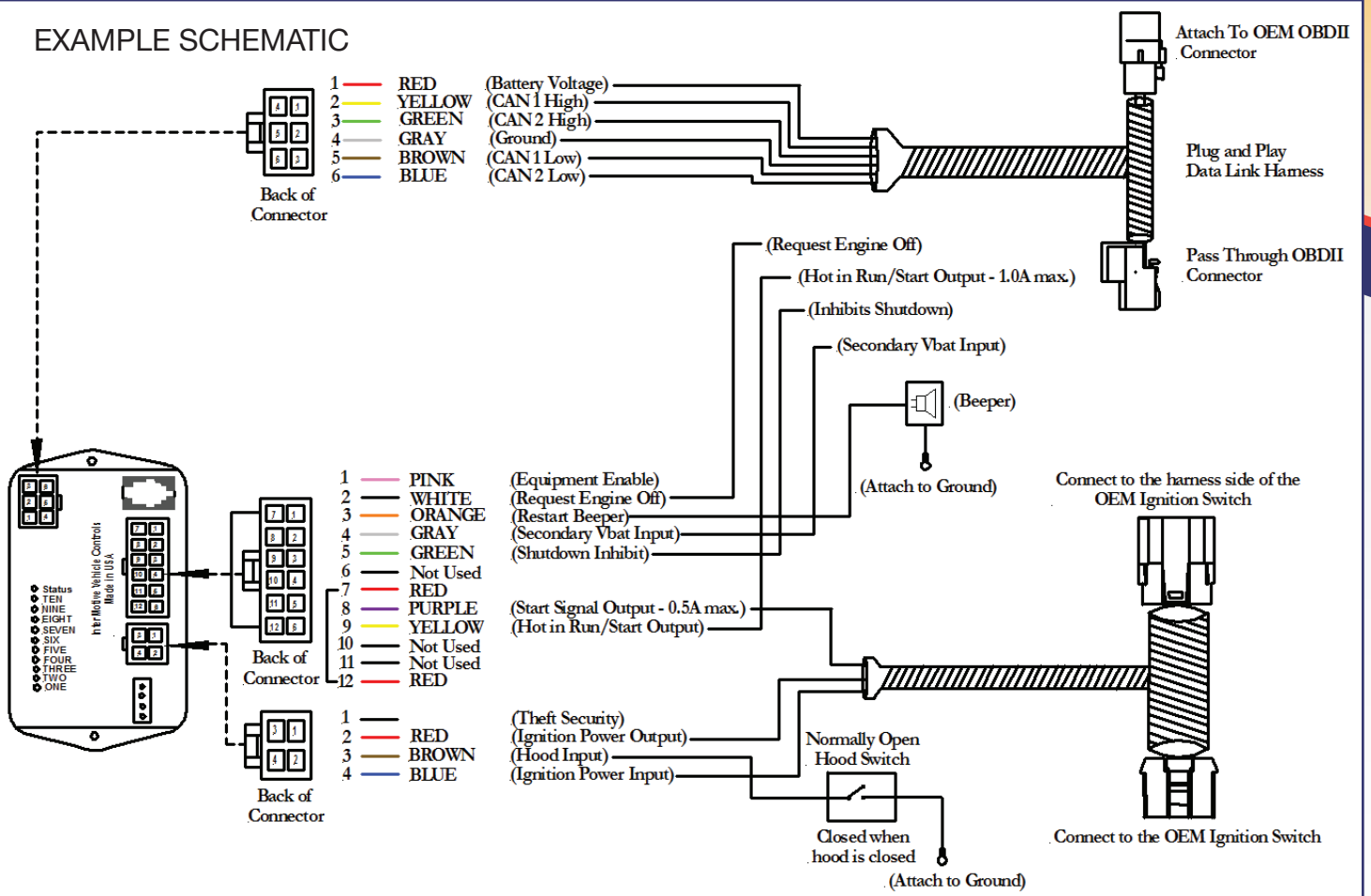

## SPECIFICATIONS

Number of Inputs Four active low inputs, one analog input

Number of Outputs Two active high outputs

Current Draw 60-120 mA

Quiescent Draw < 2 mA (sleep current)

CAN Speed High speed and medium speed

Temperature Range -40°C to 80°C

Dimensions 4" L x 2" W x 1" H