

# Instructions



## EcoStar™ III Ford

H-EC03-509-B 2023 Ford F250-F600

**\* Not for use on chassis with Push to Start ignition systems.**

## System Overview

### Introduction

EcoStar™ III (ESIII) is a configurable automatic engine stop/start system that provides improved fuel economy, lower vehicle emissions, improved engine life, and extended oil changes by shutting off the engine when appropriate. Automatic engine restarts are triggered by multiple configurable parameters: primary or secondary battery voltage, service brake, thermistor temperature and auxiliary restart input. Auto-restarts are preceded by a warning beeper sound. Battery charge protect prevents a dead battery when loads are left on. Two separate battery system inputs allow auto restarts from either a primary or auxiliary battery source. ESIII can fast idle the engine based on configurable triggers: primary or secondary battery voltage, park brake, AC, heater boost and external input. A hood switch interlock input disables the system when the hood is open.

ESIII operates key in and key out, combining the advantages of the EcoStar and EcoLock systems. With the key in, the system does not require any driver interaction. This passive operation leads to greater fuel savings. With the key out, the system provides more security. During key out operation the shifter is locked in the Park position.

The following are the default vehicle safety and functional pre-conditions for Auto Stop and Auto Restart. These and other parameters may be altered to suit specific needs. A new configuration file can be loaded with the InterMotive Download Manager. Configuration changes can be made with the InterMotive EcoStar™ III Mobile App.

Auto Stop Defaults	Auto Restart Defaults
Vehicle Hood = Closed	Vehicle Hood = Closed
Trans Range = Park or Neutral (Speed = 0)	Trans Range = Park or Neutral (Speed = 0)
Battery Voltages > 12.0 V	Engine Auto-Stopped by ESIII
Brake Pedal = Not Pressed	Ignition Key in Run Position
Engine On Request = Not Active	
Thermistor Trigger = Not Active	

When all Auto Stop conditions are met, the ESIII will automatically stop the engine when the idle timer expires or an external discrete wire Ignition Off Request is activated. The default idle timer is set to 15 seconds.

### ESIII Add-On Options

- T: Thermistor for temperature activated Auto Restart.
- B: Hood Switch to allow Auto Restart only when hood is closed.
- K: Engine kill on service brake (key out active)
- G F250-600 6.7L Diesel Engine 1200 RPM SEIC AFIS Kit
- G3 F250-600 Gas Engine 1500RPM SEIC AFIS Kit

# Instructions

## IMPORTANT — READ BEFORE INSTALLATION

It is the installer's responsibility to route and secure all wiring harnesses where they cannot be damaged by sharp objects, mechanical moving parts and high heat sources. Failure to do so could result in damage to the system or vehicle and create possible safety concerns for the operator and passengers.

Avoid placing the module where it could encounter strong magnetic fields from high current cabling connected to motors, solenoids, etc. Avoid radio frequency energy from antennas or inverters next to the module. Avoid high voltage spikes in vehicle wiring by always using diode clamped relays and solenoids when installing upfitter circuits.

## CAUTION

All electronic products are susceptible to damage from Electrostatic Discharge or ESD. Ground yourself before handling or working with the module and harnessing by first touching chassis ground, such as the barrel of the cigarette lighter.



## Installation Instructions

**Disconnect vehicle battery before proceeding with installation.**



**WARNING**  
Disconnect the battery to  
prevent setting a check engine  
light.

### ESIII Module

Remove the lower dash panel below the steering column and find a suitable location to mount the module. Locate the module in an area away from excessive heat sources (engine, heater ducts, etc.). Ensure when routing harnesses that the tilt steering column does not contact them in the full down position. When installing the harnesses, leave several inches of take-out so the module can be removed if necessary. Do not mount module until all wire harnesses are routed and secure. The last step of the installation is to mount the module.

### Data Link Harness Installation

The 2023 Ford Super Duty has an OEM Gateway module located on the other side of the SYNC 4 module, which is behind the center console. Follow the steps below to access it:



1. Remove the RH instrument panel trim using a trim removal tool. The trim starts at the ignition switch and ends at the silver clip. The glove compartment can be opened to better access the back side of the trim.



# Instructions

- Using a trim removal tool, pop out the upper right corner of the lower steering column close out panel. Position it away from the center stack.



- Remove the 4 bolts (Size: 7mm) located at the top of the center stack.



- Release the clips on both sides of the center stack using a trim removal tool. Position the center stack away from the mounting points.



# Instructions

5. Disconnect the 2 connectors behind the center stack

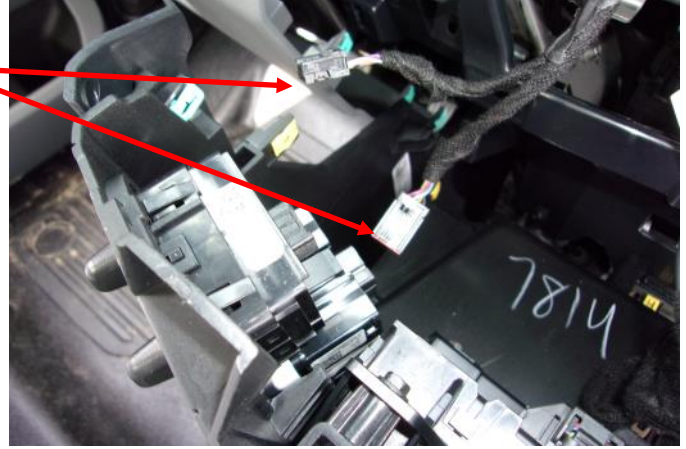

6. Detach the push-mount cable tie from the bracket and position the cable out of the way.

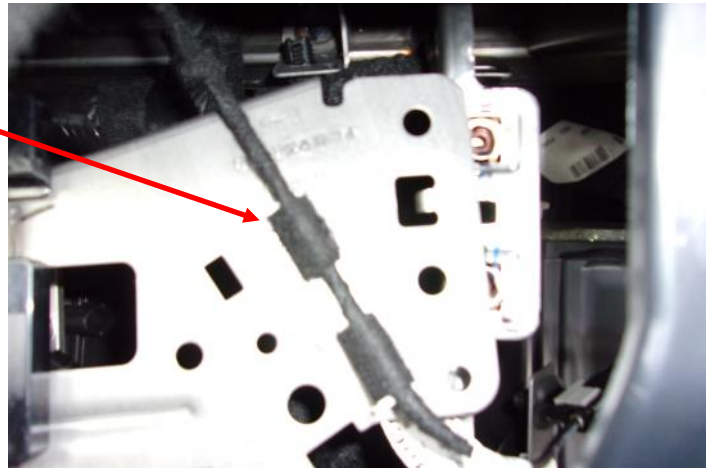

7. Remove the 4 bolts (Size: 7mm) and position the bracket away from the mounting points to access the Gateway Module. The Gateway Module is located behind the bracket.



## Instructions

8. Disconnect the Gateway Connector by pressing down on the tab and pulling the connector away from the module.

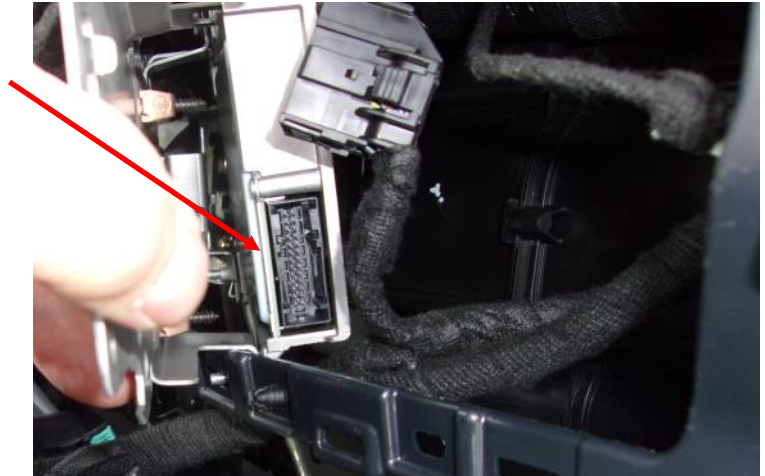

9. Install the Datalink Harness between the Gateway Module and the disconnected Gateway Connector.



10. Run the 6-pin connector of the datalink harness to the mounting location of the module.

# Instructions

## Shift Lock Harness

1. Remove the upper and lower steering column covers by removing the 3 screws in the lower column cover.



2. Locate the Shift Lock (4-pin) harness.
3. Unplug the Shift Lock connector.
4. Plug the OEM Shift Lock connector into the mating connector on the ECO3 harness.

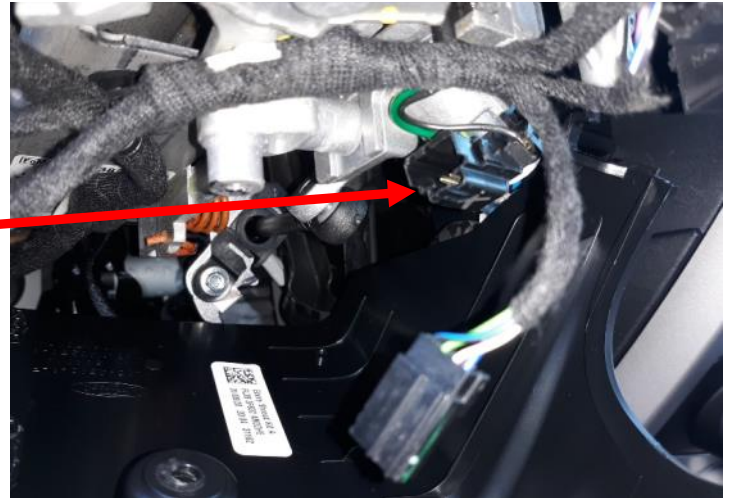

# Instructions

## EcoStar Key Out Enable Switch with Active LED (S-H84GX)

A switch with LED is provided in the kit.

1. Drill a 16mm (0.630") hole in the desired mounting location. One possibility is the dash panel to the left of the Steering Wheel.
2. Route the switch and LED harness through the hole and mount it in the hole.
3. Slide the switch and LED's lock nut onto the harness and snug it down onto the back of the switch.
4. Plug in the 4 pin (Black) connector of the S-H84GX harness into the mating connector on the EcoStar main harness. **NOTE: this harness does not plug into the module J2 connector.**



## Ignition Switch Connections

1. Remove the left side trim piece using a trim removal tool. There are several clips and a "tree" plug securing it to the dash.



# Instructions

2. Remove the dash upper trim using a trim removal tool. It is attached by multiple clips. (Trim piece already removed in picture)



3. Remove (3) 7mm screws securing the Instrument Panel Surround to the dash.

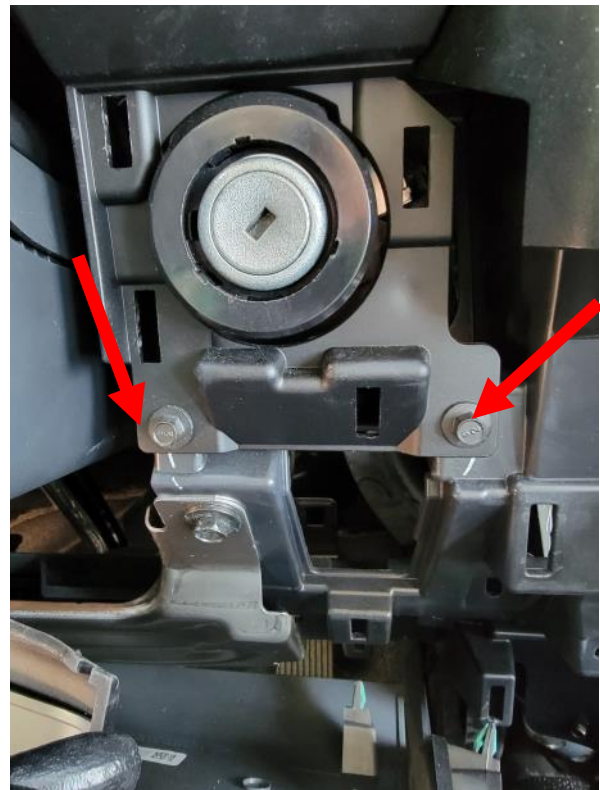



## Instructions

4. Lower the steering column and pull the Instrument Panel Surround away from the dash. There are a couple clips securing it to the dash. Connector C250 is on the bottom side of the ignition switch. Plug the mating ends of the InterMotive ignition harness into the ignition switch and OEM harness.
5. Route the harness to the mounting location of the ESIII module.

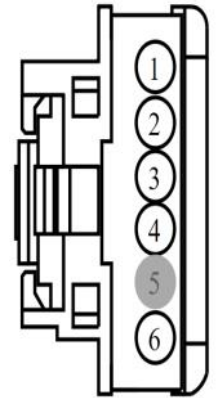
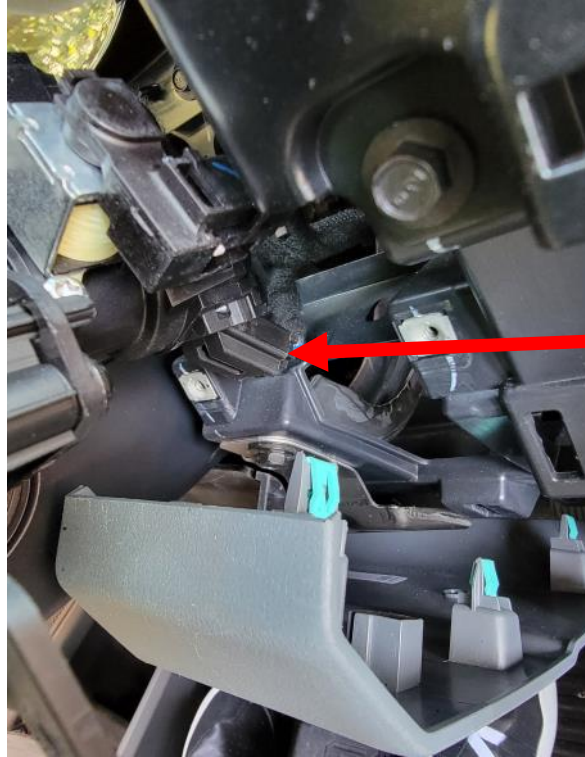

**C250**  
Front of  
Connector

### Connect Harnesses to Module

1. Plug the 16-Pin harness connector into the mating 16-Pin J7 connector on the module.
2. Plug the 8-Pin harness connector into the mating 8-Pin J4 connector on the module.
3. Plug the 4-Pin harness connector into the mating 4-Pin J8 connector on the module.
4. Plug the 4-Pin harness connector into the mating 4-Pin J5 connector on the module.
5. Plug the 4-Pin harness connector into the mating 4-Pin J2 connector on the module.

**Reverse the installation procedure to reassemble.**

# Instructions

## Fast Idle

The fast idle system controls engine idle RPM in response to a number of triggers in order to increase electrical and mechanical output of the vehicle. By default, gas engines idle at 1500 RPM while diesel engines idle at 1200 RPM.

### Fast Idle Engage Input (8-Pin Connector)

Input 3 can be configured as a fast idle engage input. Attach the harness connector Pin #3 Yellow/Blue wire on the 8 pin connector to any equipment that provides a **power signal when the fast idle needs to be engaged**. (PTO, pump, etc.)

### Fast Idle SEIC connections

ECO3 can no longer Fast Idle the Ford Super Duty over the CAN network. Beginning in 2023, the following connections must be made:

1. Locate the Customer Access 25-pin harness located behind the passenger kick panel.
2. The mating 25-pin pigtail is included with the vehicle and will be located in the vehicle's glovebox.
3. Using solder and heat shrink, connect the following wires together:
  - **Diesel:** White/Brown wire from the InterMotive SEIC harness to the White/Brown wire of the OEM 25-pin pigtail.
  - **Gas:** Green/Violet wire from the InterMotive SEIC harness to the White/Brown wire of the OEM 25-pin pigtail.
  - Yellow/Green wire from the InterMotive SEIC harness to the Yellow/Green wire (Pin 7) of the OEM 25-pin pigtail.
  - Green wire from the InterMotive SEIC harness to the Green/White wire (Pin 5) of the OEM 25-pin pigtail.
4. Plug the Yellow/Green wire from the InterMotive SEIC Harness into the configured SEIC output of the 4-way J5 connector or 2-way J12 connector.

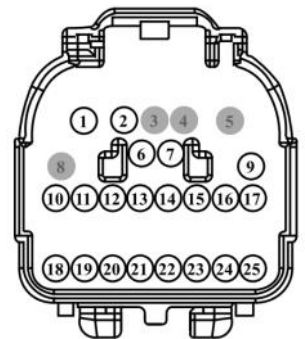

840-00058

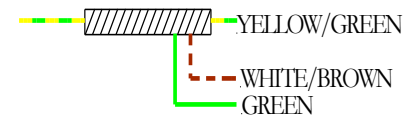

840-00296



### Configurable Fast Idle Triggers

- Primary Battery
- Auxiliary Battery
- Park Brake
- A/C, Heater Boost
- External Request

### Fast Idle Preconditions

The following preconditions must be met prior to initiating Fast Idle operation:

- Vehicle speed zero
- Transmission in Park
- Accelerator pedal not applied
- Engine Coolant temperature less than 230°F
- Engine RPM must be greater than 200 and less than 2800
- Service Brake not applied
- Parking Brake must be applied if this feature is enabled

## Instructions

**I/O Features and Descriptions:** (Solder and heat shrink all connections)

### Key Out Enable Input

Pin #2 (Gray wire) of the 8-pin J4 Connector is the Key Out Enable input. This input connects to momentary switch supplied in the ESIII kit. This enable input is high true (12V). When the momentary button is pressed and released, an LED integral to the button will flash rapidly. Then the user can remove the key within a pre-configured amount of time to activate key out mode. The default period of time is 3 seconds. If key out mode is successfully activated, the integral LED will continue to flash every two seconds. If the key is not removed within the time period the LED will flash rapidly and stop flashing.

### Ignition/Engine Off Request Input

Pin #4 (White wire) of the 8-Pin J4 Connector is an Engine Off Request input. Grounding this wire with a switch allows remote engine shutoff capability. Keeping this input grounded will keep the ignition switch power off (exceptions: a remote Engine On Request, low battery OR thermistor restart trigger **will** restore ignition power and restart the engine). Leaving the ignition off after an Engine Off request reduces the draw on the battery to a minimum, allowing the greatest amount of time between low battery restarts.

### Engine On Request Input

Pin #6 (Green wire) of the 8-Pin J4 Connector is the Engine On Request input which may be wired to vehicle equipment which requires the engine to continue running. **This switch input must provide a ground when restart is desired.** Solder and heat shrink all connections. This input also acts as a Shutdown Inhibit. As long as it is active (grounded), the Anti-Idle shutdown timer and the Request Engine/Ignition Off inputs will not turn the vehicle off.

An optional thermistor may be attached to the Engine On input if a temperature activated auto-restart is desired. The thermistor option may be used to auto restart the engine as a result of either cold or hot temperatures. For example, it may be used to prevent the engine from getting too cold in severe environments. It may also be used in police K9 vehicles to prevent cabin temperature extremes. Mount the thermistor in a location where it cannot be damaged by sharp objects and mechanical moving parts such as the Park Brake or tilt steering wheel mechanisms.

- **Low Temperature Thermostat Engine Cycling** Assumes the cabin heater is turned on. If the cabin temperature does not increase 6 minutes after a low temperature restart the thermostat is disabled until the key is cycled.
- **High Temperature Thermostat Engine Cycling** Assumes the cabin air conditioner is turned On. If the cabin temperature does not decrease 6 minutes after a high temperature restart, the thermostat is disabled until the key is cycled.

### Hood Open Disable Switch

The Hood Open Disable Switch is **not** an optional input. This grounding connection **must** be made in order for the module to operate. It is one of the most important safety features and the time must be taken to properly install a switch such that a ground contact is made only with the hood fully closed.

Pin #7 (Brown wire) of the 8-pin J4 connector is the Hood Open Disable input. As an important safety feature, this connection must be made to prevent auto restarting when someone is working under the hood area. Extend the Brown Hood Open Disable wire through the bulkhead into the engine compartment (solder and heat shrink all connections). Attach the Hood Open Disable wire to a normally open hood switch that grounds this signal when the hood is closed. A low current switch with gold contacts is recommended.

# Instructions

## I/O Features and Descriptions (continued)

### Aux Battery Input (Up to 60 Volt)

Pin #8 (Gray wire) of the 8-Pin J4 Connector is an auxiliary battery voltage monitor input. It measures the analog battery input and can trigger a low battery restart when this input falls below a user defined level. By default this trigger is disabled, but it may be enabled via the ESIII mobile app. Contact InterMotive for details.

### Restart Beeper

Pin #2 (Orange wire) of the 4-Pin J5 Connector drives a warning beeper that will sound for 2 seconds prior to all restarts except Service Brake restarts.

1. Find a suitable location for mounting the warning beeper so that it is audible to the driver.
2. Connect the Orange lead to Red post of beeper and the Black lead to the negative post.

Rotate the bezel on the beeper to control volume.

### Configurable Low Current Outputs

Pin #3 of J5 (Yellow wire) (0.5 Amp Max) , Pin #4 of J5 (Pink wire) (1 Amp Max), Pin #1 of J12 (Tan wire) (0.5 Amp Max) and Pin #2 of J12 (Light Green wire) (0.5 Amp Max) are configurable outputs. These outputs can be configured with one of the following 9 logic modes.

#### 1. Lock Mode

When configured for lock mode, an output can control installer supplied normally closed relays to secure equipment when key out is active (e.g. trunk and weapon rack release buttons in police applications). When ESIII activates this output, the relays will open the circuits from the buttons and disable them. This minimizes possible theft when ESIII is active and the vehicle is unattended.

When ESIII is enabled, this output becomes active after a configurable delay. (default 10 seconds) This output remains active until the key is back in the run position.

If an attempted theft is detected and ESIII disables, this output will still remain active until the key is back in the run position.

#### 2. Key Out Active

An output using this logic mode can control installer supplied normally closed relays or auxiliary indicator LEDs. This output can enable/disable equipment while ESIII is cycling the engine in key out mode. When key out operation is enabled, this output becomes active. This output remains active until the key is back in the run position.

If an attempted theft is detected and ESIII disables, **this output will turn off.**

#### 3. Equipment Enable

An equipment enable output will force the operator to depend on ESIII stop/start capability in order to use their equipment. This output is only active when the Request Engine Off input is active. While this input is active, ESIII will cycle the engine based on primary/secondary battery Voltages and the Request Engine On input (which includes the optional thermostat function).

The Equipment Enable Load Output is similar to the Un-Interrupted Load Output. The difference is that this load ensures that Eco-Star is cycling the engine. In the case of the Un-Interrupted Load Output, there are ways to disable the stop/start capabilities of Eco-Star (disable idle timer or set to 30 minute idle time) while retaining the output.

## Instructions

### 4. Un-Interrupted Load Control

ESIII shuts down the vehicle's engine by simulating key OFF or ACCESSORY condition. All electrical loads that normally shut off when the key is in the simulated position will lose power. This may not be desirable for all loads and can be avoided by wiring an external relay to an ESIII output configured with this mode (continue reading for proper relay wiring).

The Ignition Power Signal will normally activate only when the key is in the Run/Start position. However, when EcoStar is commanding Ignition Off, the Ignition Power Signal becomes Key In Ignition. These loads will drain the battery faster. Use of LED lights and higher capacity batteries is recommended.

### 5. Engine Run

An output with this logic mode will turn on when the engine is running. This logic mode can be used to disable equipment when the engine is not running.

### 6. Theft Alarm

The output will pulse during theft alarm sequence. Connect to auxiliary visual or audible alarm equipment.

### 7. AFIS Trigger

The output will activate when the AFIS conditions are met to trigger fast idle. This output can be connected to OEM SEIC wires on 2020 MY and later diesel engines (see page 9).

### 8. Door Lock

The output will activate for 250 ms when the OEM doors are locked. This output can be connected to non-OEM locks for doors or storage containers.

### 9. Door Unlock

The output will activate for 250 ms when the OEM doors are unlocked. This output can be connected to non-OEM locks for doors or storage containers.

Pin #3 of J5 (Yellow wire), Pin #1 of J12 (Tan wire), and Pin #2 of J12 (Light Green wire) are capable of driving up to 0.5 Amp max. Pin #4 of J5 (Pink Wire) is capable of driving up to 1 Amp max. When connecting to a relay, always use a diode clamped relay, such as Digikey part number PB682-ND, or add a diode across the relay coil as shown, observing the required polarity. The use of a relay without diode clamped suppression causes high voltage spikes when the relay coil is deactivated. These voltage spikes may cause damage or intermittent behavior to on-board vehicle control modules. Resistors and other methods of clamping are not as effective and are not recommended.

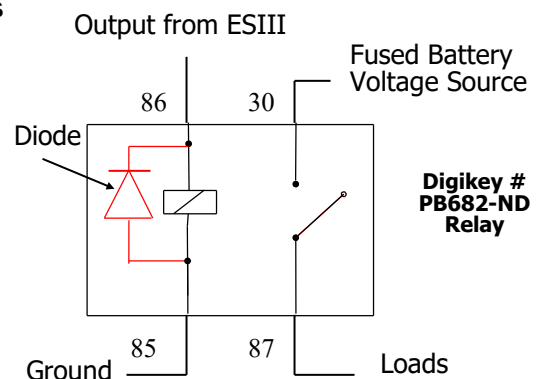

### Configurable Shift Lock/Fast Idle Input

Pin #3 of J4 (Yellow Blue wire) (+12V) is a configurable input. ESIII can use this input as a shift lock trigger, a fast idle trigger, or both. The configuration can be adjusted with the EcoStar III mobile app.

# Instructions

## ESIII Module Mounting

Ensure all harnesses are properly connected and routed and are not hanging below the dash area. Mount the module as described on page one, and secure with two screws or double sided tape.

### Reconnect vehicle battery

## Post Installation Operational Test

**Test 1.** With engine running, transmission in Park or Neutral, hood closed, activate the Engine Off Request switch input. Engine will shut off, ignition will be held off.

**Test 2.** Release the Engine Off Request. Ignition power will be restored, loads that are powered with key in Run will be restored. Engine will not start (low battery could cause a restart).

**Test 3.** Activate the Engine On Request input. The Engine will automatically restart.

**Test 4.** Release the Engine On Request and confirm the module shuts off the engine after \*15 seconds. Note: Applying the Service Brake may prevent the timer from counting down and shutting off the engine.

**Test 5.** Start the engine and enable key out operation by pressing the enable button and removing the key within \*3 seconds. If successful, the LED that is integral with the button will continue to flash.

**Test 6.** Confirm the module shuts off the engine after \*2 seconds.

**Test 7.** Repeat test 3 with hood open. As a safety feature, the ESIII MUST NOT start or stop the engine when the hood is open. If the Engine Start Request starts engine with hood open, check hood switch wiring.

**Test 8. OPTIONAL.** Verify fast idle activates based on configured triggers. If using SEIC for fast idle the park brake must be set.

**NOTE:** ESIII will not shut off the engine for 5 seconds after the engine is started. If ECO3 detects the Ford shutdown feature, it will automatically override the timer. No customer action is required.

\*These values are configurable and may change from the stated default values.

**Do not put vehicle in service unless hood open disables EcoStar™ III from auto restarting engine.**

**If the system fails any of the above tests, check the related wiring. If necessary, call InterMotive Technical Support. Do NOT release vehicle for service unless it has passed all of the above tests.**

## Want to change default settings?

To make changes to the default EcoStar™ III configuration, use the InterMotive EcoStar™ III Mobile App. The app allows you to view or modify any of the ESIII configurable parameters. If the configuration is altered, make note of the modifications for future serviceability and include them with the vehicle.

# Instructions

## Leave in vehicle Operating Instructions EcoStar™ III Ford H-EC03-509-B 2023 Ford F250-F600

- EcoStar™ III (ESIII) provides enhanced fuel economy and lower vehicle emissions for customers by limiting engine idle time. Vehicle fuel economy is improved by automatically shutting off the vehicle's engine to prevent unnecessary idling. Restarts can be automatically triggered by low battery voltage, Service Brake, remote equipment operator requests, or thermostat restart trigger (if enabled).
- The system can operate key in (no driver interaction required) or key out by pressing the key out enable button and removing the key within 3 seconds (configurable). During key out operation the shifter is locked and idle timer is 2 seconds. The LED integral with the enable button will flash while key out is active.
- The Engine Off Request is a remote switch that when activated turns the engine off by switching off ignition power. The ignition remains off until: 1) Engine Off Request is removed, 2) Low battery causes a restart, 3) a remote Engine Start Request switch is activated or 4) Thermostat triggered restart. The module keeps ignition off to reduce the demand on the batteries, thereby delaying a low battery restart as long as possible.
- The Engine will also be auto-stopped when the idle time exceeds the time out period. The default timeout period is 15 seconds of idling in Park or Neutral. After that period elapses, the engine will be automatically turned off. Note that the Service Brake and the Engine On switch will prevent idle timer shutdown. If ECO3 detects the Ford shutdown feature, it will automatically override the timer. No customer action is required.
- The Engine On Request switch, if installed, is a remote trigger that, when activated, will start the engine after an auto-stop has occurred. Activating the Engine On Request while the vehicle is running will prevent all auto-stops from occurring. If the vehicle is equipped with the optional thermistor, the vehicle may auto-restart and shut off based on temperature
- Once the engine has been auto-stopped, ESIII monitors the main battery voltage (an auxiliary battery may also be monitored). If either fall below a minimum restart voltage, the module will sound an alarm for 2 seconds and auto-restart the vehicle to recharge the batteries. The default restart value is 12.0 Volts for the main battery (aux battery input is disabled). Once the main battery charges above 13.5 volts, a recharge timer of 900 seconds begins that will turn off the engine again.
- ESIII will fast idle the engine based on configurable triggers: primary or secondary battery voltage, park brake, AC, heater boost and an external input.
- An ESIII mobile app is available to view idle reduction stats, view or modify the configuration, and perform system diagnostics.

### Default requirements for engine auto-stop

Transmission in Park or Neutral (vehicle not moving), Hood Closed, Service Brake not applied, Battery Voltage greater than 12.0 Volts (may differ from default setting), no thermostat trigger, and Engine Restart switch must not be "on" (this switch input overrides the Engine Off Request and Idle Timer).

### Default requirements for engine auto-restart

Hood Closed, Engine must have been auto-stopped, Transmission in Park or Neutral, and the key in the Run position.

Once above conditions are met, the engine will restart when the Engine On Request is activated, a low battery is detected or Thermostat restart trigger is activated.

The ESIII may be removed from the vehicle by unplugging the ESIII 6 pin harness (behind lower drivers dash panel) and restoring the OEM ignition switch wiring.

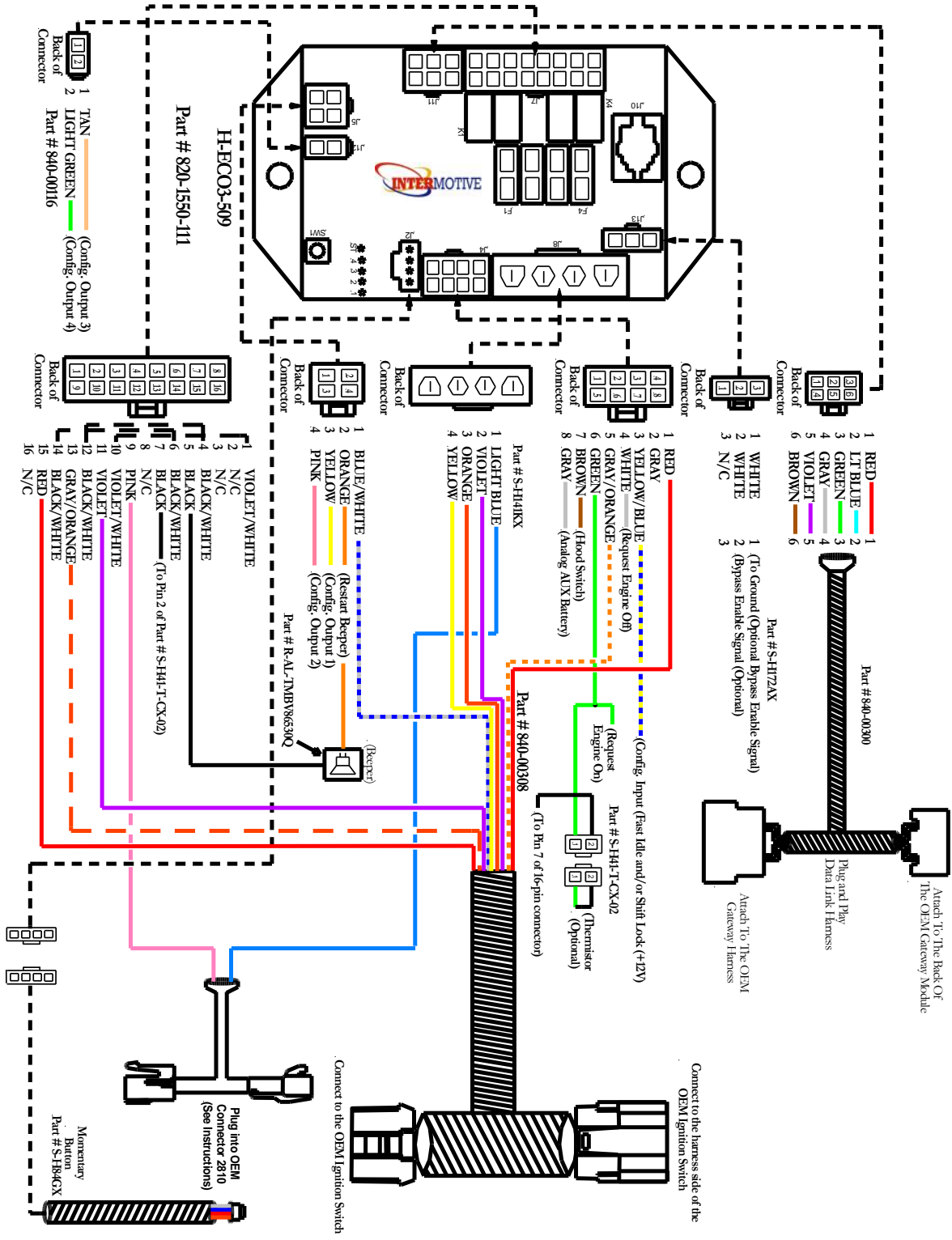

Submit product registration at [www.intermotive.net](http://www.intermotive.net)

If the ESIII-509 fails any step in the Post Installation Check List, review the installation instructions and check all connections.  
 If necessary, call Intermotive Technical Support at (530) 823-1048.