Merlin

Operations Manual





Table of Contents

1	INTRODUCTION	3
1.1	INTRODUCTION.....	3
1.2	PRODUCT OVERVIEW.....	3
1.3	OBJECTIVES.....	4
2	SYSTEM OVERVIEW.....	4
2.1	SYSTEM REQUIREMENTS	4
2.2	FEATURES.....	4
2.2.1	<i>Brown Out</i>	4
2.2.2	<i>Delayed Sleep Mode</i>	4
2.2.3	<i>Fault Control (programmable)</i>	5
2.2.4	<i>Vehicle Data (programmable)</i>	5
2.2.5	<i>Load Shedding (programmable)</i>	5
2.2.6	<i>Load Scheduling</i>	5
2.2.7	<i>Door Control</i>	5
2.2.8	<i>Warning Messages (programmable)</i>	6
2.2.9	<i>System "Diagnostic" Mode</i>	6
3	SYSTEM COMPONENTS	6
3.1	INTELLIGENT SWITCH PANEL (ISP).....	6
3.1.1	<i>Overview</i>	6
3.1.2	<i>Operation</i>	8
3.2	DIGITAL POWER CENTER: (DPC8 OR DPC4).....	9
3.2.1	<i>Overview</i>	9
3.3	GATEWAY AI (GW).....	9
4	CONFIGURATION REPORT.....	10
4.1	SYSTEM MODULES	10
4.2	SYSTEM LOAD SHEDDING.....	12
4.3	SYSTEM WARNINGS	12
5	DIAGNOSTIC MENU FLOW CHART.....	13
6	SYSTEM CONFIGURATION REPORT (SAMPLE).....	22
7	REFERENCES.....	28
7.1	INTERMOTIVE VEHICLE CONTROLS.....	28

List of Figures

•	FIGURE 1: TYPICAL CONNECTION OF THE MERLIN MULTIPLEX SYSTEM©.....	3
•	FIGURE 2: INTELLIGENT SWITCH PANEL.....	7
•	FIGURE 3: ISP OUTLINE.....	8

1 INTRODUCTION

1.1 Introduction

The InterMotive Merlin Multiplex System[®] (IMMS) is a distributed power control system intended for use in passenger vehicles, light trucks, and light buses with 12 Volt electrical systems. It allows for the customization of power control throughout the vehicle while minimizing the use of long runs of heavy gauge wire.

1.2 Product Overview

The goal of the IMMS is to connect electronic modules within an automotive environment on a common control network, thereby reducing overall wiring, centralizing and improving diagnostic capabilities, and sharing valuable vehicle information between modules.

The basic IMMS consists of a Switch/Network Control module (Intelligent Switch Panel – ISP) and a Power Control module (Digital Power Center - DPC) networked on a Controller Area Network (CAN) bus. A Gateway^{AI} module is installed if vehicle data is needed by the system.

Modules on the Merlin network are connected with a pair of CAN data communication wires, a power wire, and a ground wire. Collectively, these signals form the Merlin CAN Communication bus. The open ends of the CAN communication wires must be appropriately terminated to ensure system stability. Figure 1 shows the layout of a typical Merlin System.

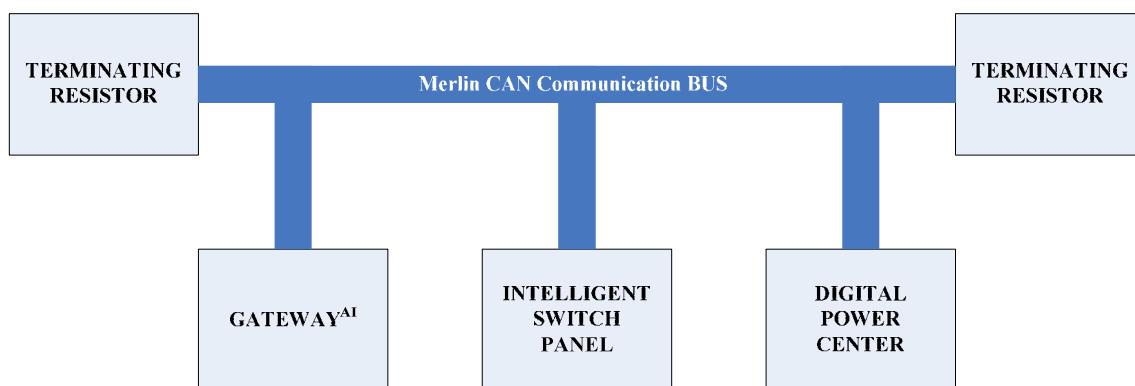

• Figure 1: Typical connection of the Merlin Multiplex System[®]



1.3 Objectives

The bus manufacturer has installed the IMMS on your vehicle(s). The purpose of this manual is to provide you with some general insights about what to expect as you operate this system. The word "general" is used here because this system is highly configurable, and the bus manufacturer has set up controls that are specific to the particular electrical loads on this vehicle. You should have been given a printout entitled "Merlin Multiplex System" (see Sec. 6.0) that contains the detailed information showing the specific configurations for your vehicle. The document represents a file that has been loaded onto the IMMS. If you don't have this document, the bus manufacturer should be able to provide it.

NOTE: it's not necessary to have this document in hand to run your vehicle, but it serves to fully convey all control aspects and can come in very handy if/when problems arise and you are troubleshooting.

2 SYSTEM OVERVIEW

2.1 System Requirements

The main vehicle requirement for the IMMS is:

- 12 Volt system

2.2 Features

The system features listed below (in no particular order) may or may not be active on your vehicle – if a feature is identified as "programmable", the bus manufacturer had the option to either include it (or configure some aspect of it) or not on your particular design. Your configuration document will give the details of this. If not labeled "programmable", the feature does exist as stated.

2.2.1 *Brown Out*

NOTE: this feature has been removed from ISP versions 1.43, 2.02 and beyond.

2.2.2 *Delayed Sleep Mode*

Whenever the vehicle system is "keyed off", the IMMS will go into a state of very low current draw (Sleep). A programmable time delay can be set up such that this will not happen immediately. This is used for example if it is necessary or reasonable to keep loads on for a time after the vehicle has been shut down.



2.2.3 *Fault Control (programmable)*

The IMMS monitors current in each of its active loads, and depending upon current limit values, loads can be turned off if current exceeds these limits. Specifically, an over and under current value can be set up. If a current value is exceeded the IMMS will turn off the load and then try to turn it on for up to 5 tries. If the load still draws too much (or too little) current, the load will be disabled (fault out) and you will not be able to turn it back on until the fault is cleared. Usually this means rebooting the system.

2.2.4 *Vehicle Data (programmable)*

If the vehicle has a Gateway^{AI} module installed, specific vehicle data becomes available to the IMMS and to the user (See discussion on the Diagnostic mode).

2.2.5 *Load Shedding (programmable)*

NOTE: this feature has been removed from ISP versions 1.43, 2.02 and beyond.

2.2.6 *Load Scheduling*

When the IMMS shuts down (goes to sleep), the system remembers which loads were ON prior to the shutdown. The same loads will be sequentially (at half second intervals) restored when the System turns back on. This prevents creating a potentially large draw on the battery when the system is first activated.

2.2.7 *Door Control*

If your vehicle is equipped with a motorized door(s) directly controlled by Merlin, the following features come into play:

1. **Sensitive Edge (programmable)** – detects when something or someone is being "pinched" by a closing door, stops the door movement, and reverses the door back to its OPEN position.
2. **One Touch (programmable)** – the ability (by momentarily pressing the Door Open button) to cause the door to completely open. NOTE: this is not available on the CLOSE command – you have to hold the button for the complete travel distance.
3. **Manual Override** – There are a number of ways to shut off a door motor load (see next section), but these can be "overridden" with this feature. If you want to "force" a door to open or close, you press, then release the Intermotive/ENTER button then press either the Door Open or Door Close button within a second of releasing the ENTER button. The only thing that will stop a moving door in this case is if the load has exceeded its over current value. This feature only works on door motors which are controlled with the Door Open and/or Door Close buttons.
4. **Limit Switch / Virtual Limits (programmable)** – These terms refer to the way in which a door load is turned OFF. The vehicle may have mechanical switches installed that define the limits of door travel. One of these (if it becomes enabled) will stop the travel in a particular direction. A



feature called Virtual Limits can also be used if there are no actual switches. A virtual limit is simply a current value that is higher than the normal running current. If a door comes up against a hard stop (as when it reaches the end of its travel), the motor current will rise, and when it passes the virtual limit value, the load will again be disabled.

NOTE, regarding virtual limits: if this is the method used on your vehicle, you may experience over time that a door is stopping early before it is fully opened or closed. This could point out that there has been some additional mechanical resistance building up. The door mechanism should be serviced and the operation will then in all probability return to normal.

5. **Remote Entry (programmable)** – feature allows the IMMS to open a door automatically through the use of a remote device.

2.2.8 *Warning Messages (programmable)*

A warning can cause an audible alarm as well as activate a flashing light on the ISP panel and display a message in the LCD panel. Some warnings (such as when the ISP cannot recognize a module that it knows should be there) are built in and not subject to modification while others are programmed to handle a particular case. The text of the message should always indicate the cause of the warning.

2.2.9 *System "Diagnostic" Mode*

This is an all-important feature on the IMMS as it not only can be used to display the status of the system but also serves as a great troubleshooting tool when used in conjunction with the configuration printout. This mode is a series of menu items that you can navigate through and select in order to arrive at the particular piece of data you are looking for. See Sec. 5 for further details.

3 SYSTEM COMPONENTS

The IMMS is composed of several major components tied together on a network as illustrated in Fig. 1. The minimum system would consist of an ISP (control) module and a DPC module to deliver power to loads. Your vehicle may be equipped with additional modules (such as the Gateway or other power modules) depending upon size and complexity.

3.1 Intelligent Switch Panel (ISP)

3.1.1 *Overview*

The Intelligent Switch Panel (ISP) is the control center of the IMMS. It is here where most loads are activated or deactivated and the place where system displays are featured.



• Figure 2: Intelligent Switch Panel

Fig. 3 shows schematically where the various controls and displays are located. The ISP buttons (2 rows of four buttons each) and the two Door buttons on the left side generally act as activation devices for the system loads. Sometimes though (depending upon the configuration file) loads will be activated by system inputs (other than an operator pressing a button). Note that each button has a "Demand LED" in its top left corner; this LED will be ON when the button is requesting activation of a load and OFF at all other times. It is meant to be a feedback to the operator that the system has recognized the button press. Above each button (except the door buttons) is the Load LED. This LED (if programmed) will illuminate as soon as the load is actually ON. You may perceive a delay between these two LEDs coming on due to the time it takes to communicate over the system network, or the Load LED may not come on at all if there is something that is preventing the load from activating.

Below each button there is a lighted section labeled "Text LED" that is there to accommodate a label or icon that illustrates the purpose of the button. Only buttons that have been enabled in the configuration file will have their text LED "lit". If there are buttons that are dark, they have no effect in your system.

All panel buttons are the momentary type, but depending on how they were configured, they can take on the aspects of (emulate) other types of switches such as a "toggle" (press once for ON – press again for OFF) or sometimes a button can have multiple ON states. It just depends on how it was programmed. This kind of information is available in the printed configuration file report.

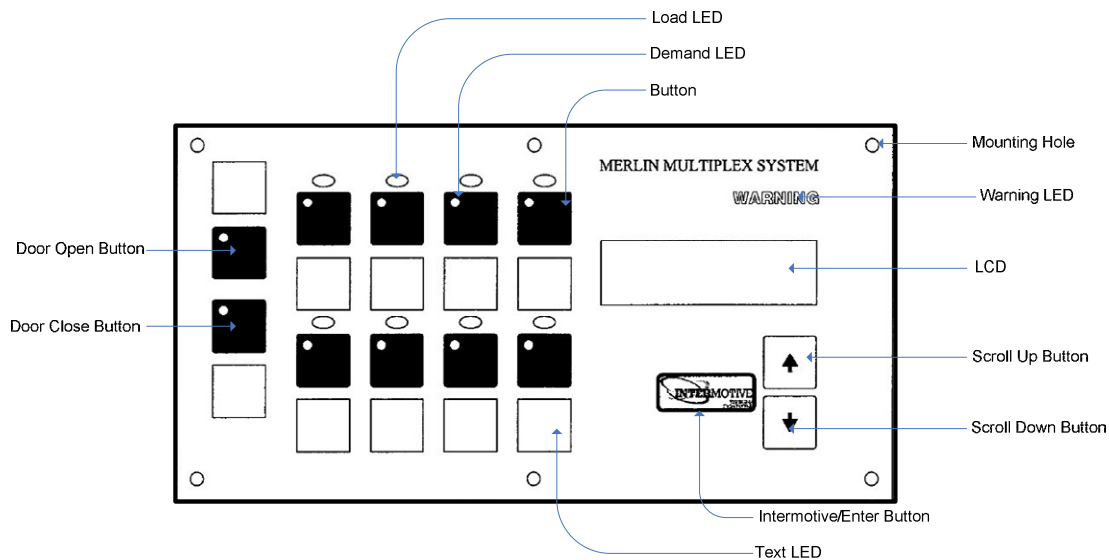

• Figure 3: ISP Outline

3.1.2 Operation

Operation of this panel is pretty straightforward – you will press buttons to activate loads and review the display to get any text message the system designer may have programmed. The LCD readout is capable of displaying 2 rows of up to 16 characters each. Messages can be "flashed" up on the LCD when loads turn on or off – the message generally displays for at least 2 seconds before returning to the default display.

When the system first boots up (usually when you key on the vehicle), the LCD will go through a number of initialization messages, and before it goes into its normal mode, it turns on all the LEDs on the front panel. They are only on for about 2 sec, but it allows you to check if there are any bad LEDs.

Turning on a load usually requires a minimum action of pressing a button, but there may be other conditions that are needed before the load can be activated. These conditions are all illustrated in the configuration printout which is taken up in Sec. 4. An example of this may be: to open a door requires that the Door Open button is pressed, but in addition the designer may have programmed in that the transmission must also be in park. In this case, the door would not open if you pushed the button, and the vehicle was sitting with the transmission in neutral.

If ever a warning is issued, you will probably see the Warning LED illuminate either constantly or flashing as well as an audible alarm and/or the message. Warnings generally stay active until the conditions causing the warning are changed.

The ISP has a built-in test mode where you are able to check all button operations. To enter this mode, press and hold the Scroll UP and Scroll DOWN buttons together as you turn on the system. The LCD will say "Entering Test" and will tell you to press buttons in order (main buttons are numbered left to right, top to bottom when looking at the ISP). If the system recognizes that you pressed the button, it moves on to



the next one and continues. If the ISP did not "see" the button press, nothing will happen, and you can conclude that there may be a problem with the physical button. If you need to skip a button (maybe it doesn't work, and you don't want to get hung up), you do this by pressing and holding the Intermotive/ENTER button while pressing (and releasing) the Door Open Button. This will allow you to skip a faulty button and continue. Once the test is complete, the system will boot up as usual.

3.2 Digital Power Center: (DPC8 or DPC4)

3.2.1 Overview

These modules are usually mounted out of sight and don't require any interaction from an operator. Your vehicle may have one or more of these modules depending upon your particular design. Each of the DPC modules has a set of input pins that can be used to monitor system status as well as output pins that are used to deliver power to electrical loads throughout the system. The DPC8 module can service up to 8 high current loads (HCOs) while the DPC4 can accommodate 4 HCOs. Each DPC module communicates with the ISP module: 1. send input and other status about the loads they are controlling. 2. receive data from the ISP in the form of requests to turn loads ON/OFF. They are also responsible for the monitoring and managing of load current.

The DPC8 module will handle all loads except the Door motors. The DPC4 module can (depending on its configuration setting) control 4 regular loads, or one door motor and two regular loads, or two door motors.

Both the DPC8 & DPC4 modules also contain 4 low current outputs (LCOs) which are sometimes used to control small loads.

3.3 Gateway AI (GW)

This is a special module which may or may not be installed on your vehicle. It is really an extension of the IMMS and not part of the system proper. It acts as an interface to other parts of the vehicle. If it is present and connected to the IMMS, it allows the following vehicle data to be available for use:

- Vehicle Speed (VSS)
- RPM
- Transmission Range (TR)
- Park Brake (PB)
- Service Brake (SB)
- Vehicle Battery Voltage (Vbat)
- Engine Coolant Temperature (ECT)
- Ambient Air Temperature (AAT)
- Transmission Fluid Temperature (TFT)
- Fuel Level %
- Lift Door Input



In addition to getting this data from the GW module, the IMMS system can command (via the GW module) the following:

1. Fast Idle
2. Shift Lock
3. Lift Inhibit

Once again, the printed configuration report will have all the details as to how this module is used (if at all) in your system.

4 CONFIGURATION REPORT

This document has been mentioned several times previously and is your guide to discovering exactly how your IMMS system operates. All programmable information used to set up your vehicle is contained in this report, but you need to know how to read it, and that is what this section is all about. Sec. 6 contains a sample report that you can refer to as you are reading through these pages. If you have the specific report that was issued for your vehicle, you could also refer to this to see how the vehicle is actually set up.

Starting with the top area of the first page, there are two pieces of text labeled "Default Message Line 1 & 2". This is the text which is displayed on the LCD (ISP Module) during normal operation (any time something else isn't displayed). The next line down indicates the amount of time the Merlin System stays awake after the vehicle is keyed OFF. This report shows 2 min. The minimum time for this is 1 min., but if this is what is indicated on your real report, expect the time to vary between 20 & 40 sec.

The report is broken down into three major sections: System Modules, System Load Shedding, and System Warnings.

4.1 System Modules

Within this section, all installed modules are included. Each module section is separated by the lines composed of "equals" (=) characters with the name of the module directly above these separator lines. The modules are also listed in a particular order as follows: ISP(required), GATEWAY AI, PM1 (DPC8), PM2 (DPC8), PM3(DPC4), PM4(DPC4), DM1(DPC4 configured as a door module), DM2(DPC4 – the second door module), DDM1(DPC4 configured as a dual door module), and DDM2(DPC4 – the second dual door module). Of course, only the modules installed in your vehicle will be included. In the sample report four modules are installed (ISP, GATEWAY, PM1, & DM1).

The first module shown in the report is the ISP. The "Panel Button Configurations" subsection shows which of the main buttons are used in your system and how each button has been programmed (Note; these buttons are also referred to as "ISP Switches" in other parts of the report). The report shows there are three buttons used in this sample system. Buttons 1 & 2 are set up to operate as a 2-pos (toggle) i.e. press once for ON, press again for OFF etc. Button 5 (the first button on the left in the second row) is a



3-pos device – press once for ON1, press again for ON2, press again for OFF etc. If this were the actual configuration for your vehicle, the first two buttons in the top row and the first button in the second row would be lit and all others would be dark.

The next section down (Input Information) shows which input pins on this module are being used for system info. and if there are any messages displayed when these inputs change state. In the example, both pins, when they become active, will display (about 2 sec.) the text shown under the "On Message" column, while if they go OFF, there is nothing displayed. Since the ISP contains no output functions, this is all the information for this module.

The next module shown is the Gateway AI module which contains one load control. The Load name is "AFIS" which is the command to the vehicle to enter the fast idle mode. Right under this is the condition which turns on this load (ISP AC Input = ON meaning that as soon as the air conditioner goes on, we need to have the fast idle activated) and which (in the absence of this condition) would turn OFF the load. This is the way all loads are depicted throughout the report. In the case of the Gateway module, the IMMS (instead of driving a load directly) "requests" of the Gateway module that it turn on the load.

Moving on, we see the next module is PM1 (a DPC8 module), and as seen there are no inputs listed here meaning no discrete system status lines are hooked up to this module. This is the first power module in the report, and as each is displayed, the HCOs and LCOs are all listed in order under the subheading "Load Information". Each module load is listed along with all its programmable parameters. Notice that not all loads are necessarily used.

The first load item is called the "type". There are potentially 13 different types for the IMMS. The majority of the time, the type will be either "Standard" (just a straight ON/OFF load) or "NOT USED" as is the case of Loads 1 & 4 here. Other types have to do with timing parameters. PM1 Load 3 is such a type. Notice that it has additional timing parameters listed. In the example report, Load 3 (when activated) will Flash on and off (0.1 sec ON then 0.1 sec OFF and repeat), and since it is also a "Delay OFF" type, once deactivated, it will delay turning OFF for 10 sec.

The next group of info shows the over and under current settings for the load and also if the load will turn off if under current is attained. If the under current value is zero then this function is inactive. Check out PM1 Load 5 to see that it has been programmed to shut OFF if the current falls below 2 amps. If load current rises above the over current value on any load, the load is always turned OFF – this constitutes a fault (See Sec. 2.2.4).

The third group contains two pieces of info. The load (if activated) can turn on one or two load LEDs on the ISP front panel and/or can display a text message on the LCD. Notice that Load 2 will turn on ISP Switch (button) 2 load LED as well as display (for about 2 sec.) the two pieces of text shown when the load is turned on and off, but Load 3 etc. does neither of these. If the module happens to be one of the door modules, there might be additional info in this group. Check out DM1 Load 2 and you'll see the extra info about Limit Switches and Remote Entry. In this case, the door has limit switches installed and is capable of opening automatically with a remote entry device.

Finally, the last group of info shows the conditions under which the load is turned ON. Notice that PM1 Load 2 is activated with just the ISP Switch (button) 2 whereas Load 3 requires the LiftDr to be open and the Lift to be deployed before it activates. Load 3 is also an example of a load which is activated without



operator intervention (there are no ISP switches listed in the condition set). Any time any of the "activate" conditions become false, the load is turned OFF.

Notice that each load as listed has (in parenthesis) a descriptive name (PM1 Load 3 would be an emergency flasher) that will give insight into what the load is controlling. These names are programmable and hopefully the system designer has included them in your report.

4.2 System Load Shedding

NOTE: For all systems running at ISP v1.43, 2.02 and beyond, this feature is no longer operational.

4.3 System Warnings

The last section in the report gives details on any warnings that have been programmed into the system. As the sample report shows, there is one warning which (when activated) will flash the warning LED, cause an audible "Tone 3" and display the shown text on lines 1 & 2 of the LCD. The warning will be activated if the LiftDr is not closed and the transmission is not in PARK.

Not all warnings are listed here as there are some that are "hard wired" so to speak into the system like when a load goes into over current or when the ISP cannot communicate with a module that is supposed to be installed. The same outcome is achieved, and the text written to the LCD will explain the reason for the warning.



5 DIAGNOSTIC MENU FLOW CHART

The following 8 pages illustrate the Diagnostic tree and all the kinds of data to be gleaned from the system. It is a matter of navigating through a series of menus in order to find a piece of data that you are looking for. Since all the data contained in the menu structure is what the system "sees" as true, and the configuration report contains all the states which have been designed (i.e. how it should work), these two tools when used together can be a great troubleshooting feature which can be utilized rather quickly.

To get into the Diagnostic mode (from normal mode) just hold down the Intermotive/ENTER button for not less than 3 seconds. Once in the mode, you use the Scroll Up & Scroll Down buttons to navigate a particular level, then press the Intermotive/ENTER button to select the menu item. As you select each item, you go deeper into the menu tree till you get to the level that contains the actual data, in which case pressing the select button will reveal the data. You will also note that each menu section has a "Previous Menu" selection which becomes your way back out to the top.

NOTE: there are a couple previously-mentioned features that are inoperable when you are working in the Diagnostic menu:

- Manual Door Override
- Sleep Function (i.e. IMMS will not go to sleep even though the vehicle is keyed off)

These are the main categories of the DIAG MENU. Each will be broken down in the pages that follow. Each sub category will have a "PREVIOUS MENU" selection to return you to the previous screen.

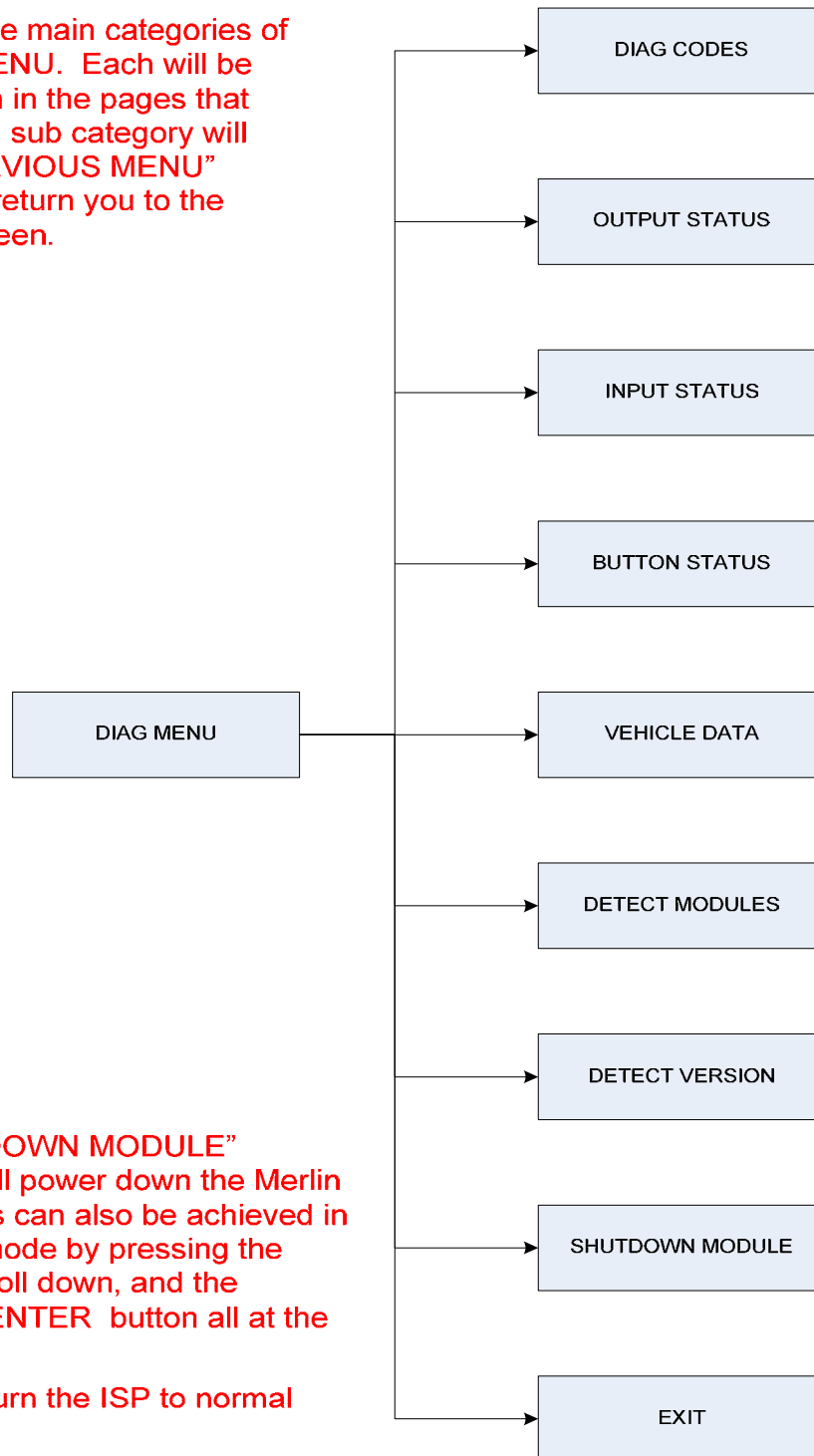

The "SHUTDOWN MODULE" command will power down the Merlin system. This can also be achieved in the normal mode by pressing the scroll up, scroll down, and the InterMotive/ENTER button all at the same time.

EXIT will return the ISP to normal operation.

Diagnostic Trouble Codes (DTC) and Fault Codes (FC), can be erased by using the InterMotive button to select “Erase All” or Erase All GW”. When an Erase command is selected the “WARNING” LED’s will flash one time and return to the top of the DIAG CODE Menu. If a DTC or FC is present, scroll down to the desired code and press the InterMotive button. As long as the button is held, the details of the code will be displayed.

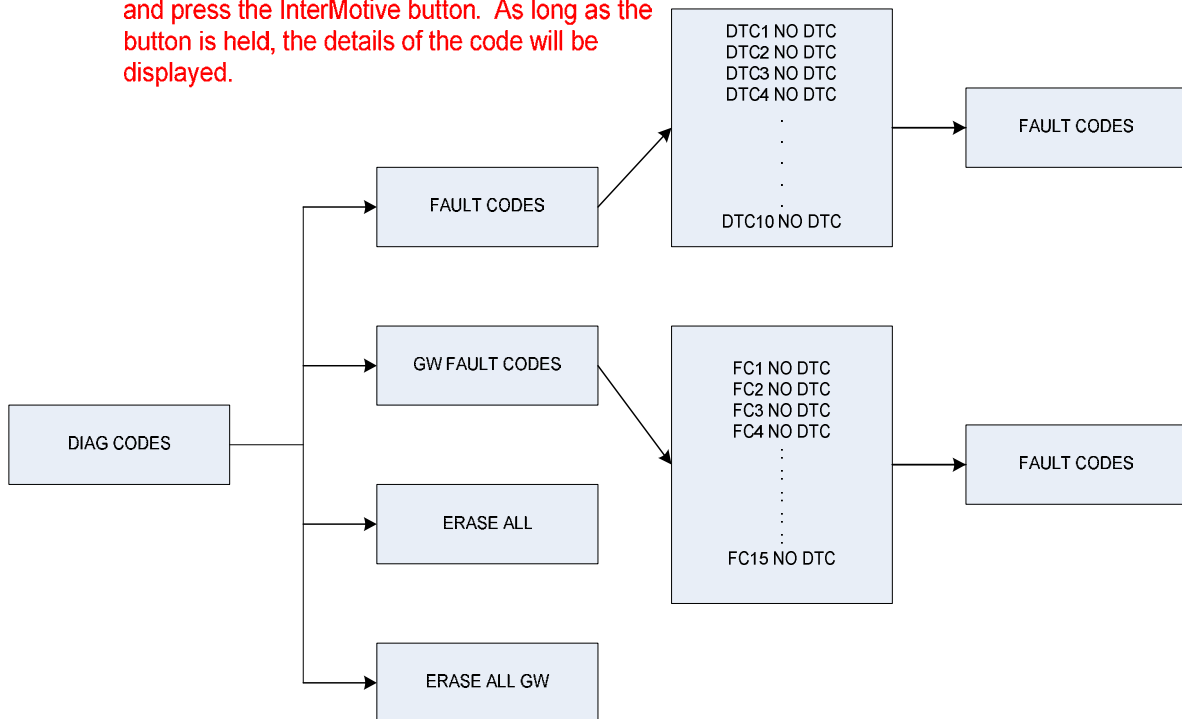

Definitions:

- GW - Gateway
- DTC - Diagnostic Trouble Code
- FC - Fault Code
- HCO - High Current Output
- OVC - Over Current
- UDC - Under Current
- NO VBAT – No Battery Voltage
- NO DETECT – Module not detected

Note: Any Fault conditions that occur while in DIAG MODE will not alarm until the ISP is returned to normal mode. The “Fault Code” menu will be updated immediately. If the codes are cleared and the ISP is returned to normal mode, warnings may appear on the screen but may not be present in the “Fault Code” menu.

This menu will give the current state, desired state, and limitations of a specific High Current Output (HCO). The current state and desired state of the Low Current Outputs (LCO) can also be viewed in this menu.

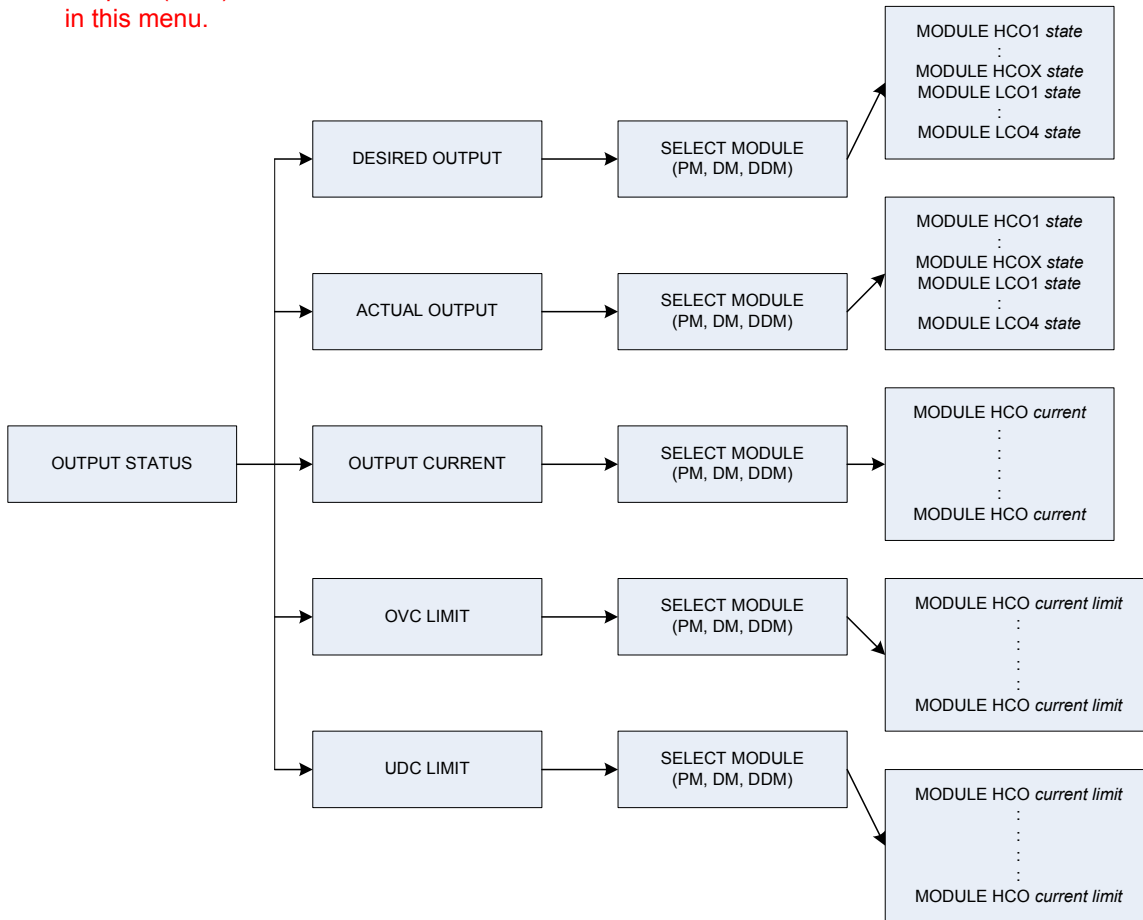

The current state of any Digital Input in the Merlin system will be displayed in this menu.

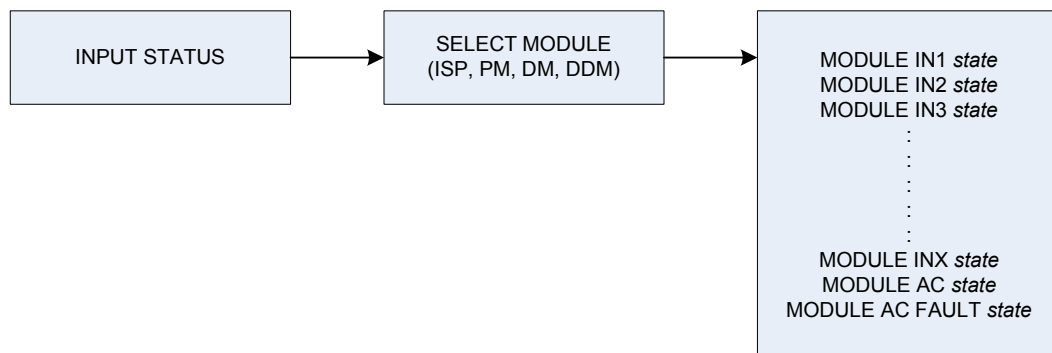

The current state of an
ISP front panel button
will be displayed in this
menu.

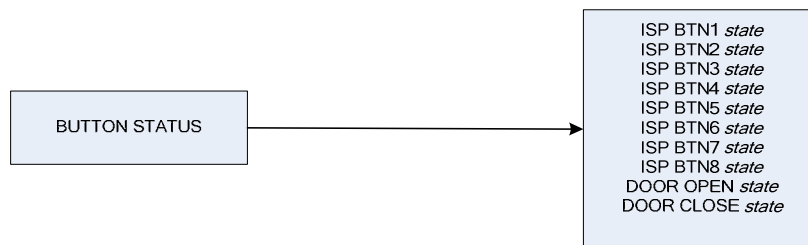

All vehicle data will be sent to the Merlin System by the Gateway. If the vehicle IGN is not on, or if a Gateway is not installed most of the information will not be displayed.

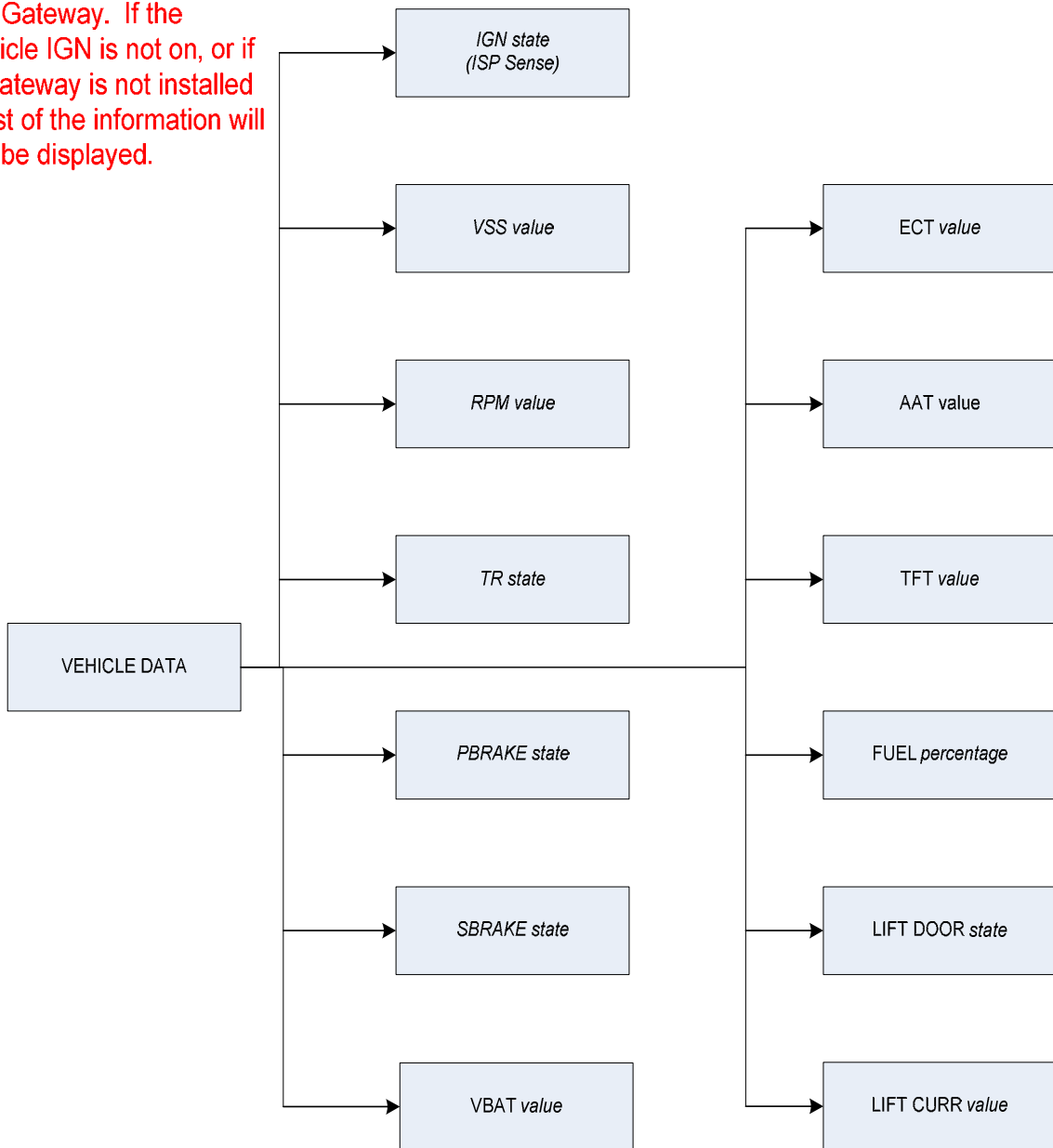

If a module has been enabled for the system and the ISP can communicate with it, the status value will read "DETECT" otherwise a "NO DETECT" value will be displayed.

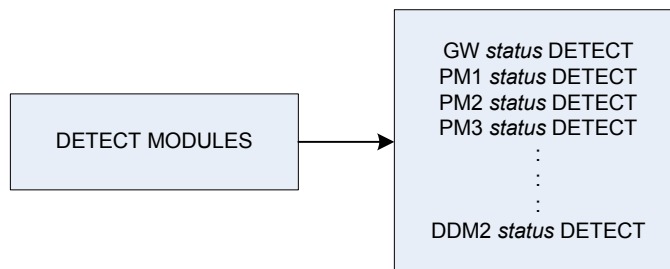

The Firmware Version of each module is shown in this menu. If the module is not installed, the version will read 0.0.

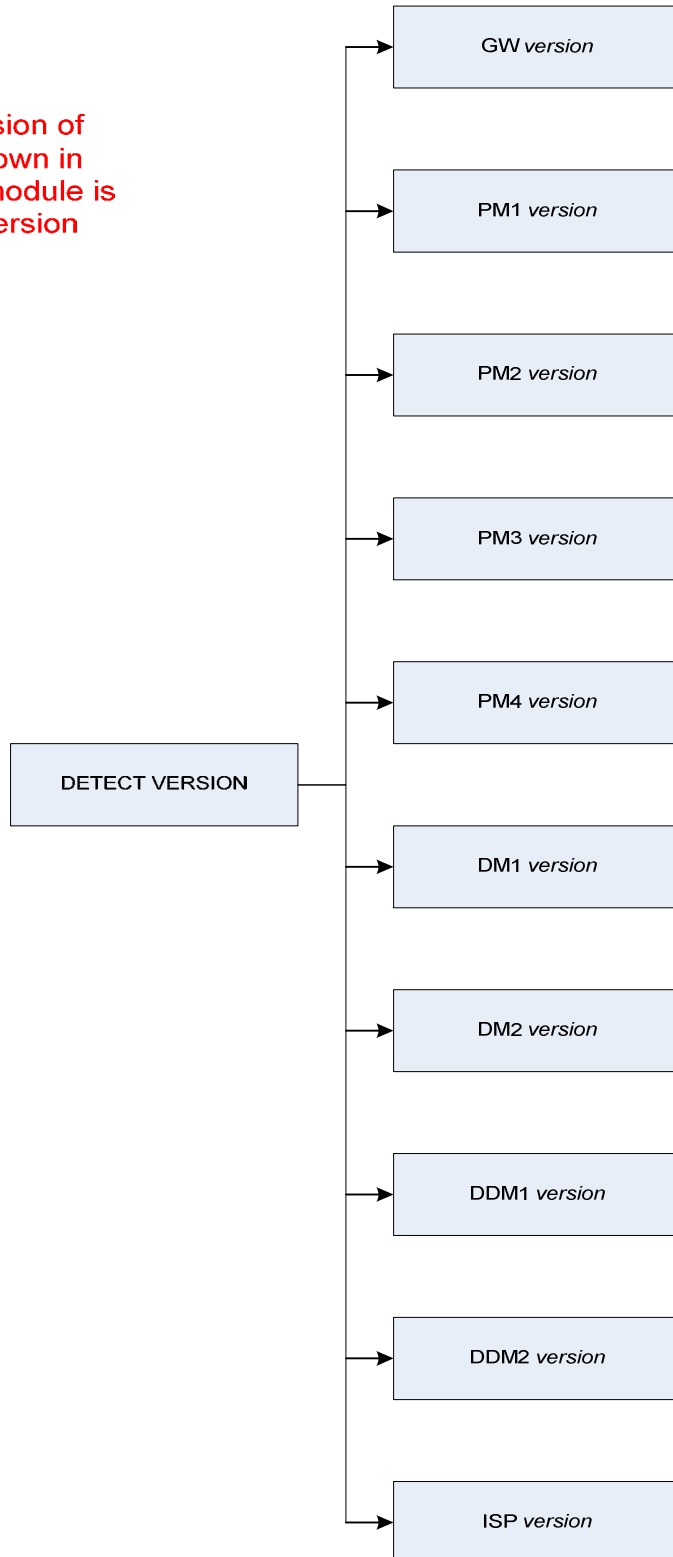



6 SYSTEM CONFIGURATION REPORT (sample)

M E R L I N M U L T I P L E X S Y S T E M
[SYSTEM CONFIGURATION REPORT]

MOW vers: 3.10

File Name: SmplConfig.MMS

Print Date: Mar 7, 2008

Manufacturer: XYZ BUS MFG.
Default Message Line 1: Any Town, USA
Default Message Line 2: Transit Auth.
ISP Delay-before-Sleep Time: 2 Minutes

**** S Y S T E M M O D U L E S ****

Intelligent Switch Panel (ISP)

=====

>>> Panel Button Configurations

Button #1: 2-Position
Button #2: 2-Position
Button #5: 3-Position

There are 5 of 8 currently unused Buttons

>>> Input Information; PCB input:(J3/pins 1 - 9)

Pin	Label	On Message	Off Message
1	LiftDr	Lift Dr OPEN	
4	LiftOut	Lift Deployed	

There are 7 of 9 currently unused Inputs

GATEWAY AI

=====

Load: AFIS

Load Activated when:

ISP AC Input = On

ConditionSet: FastIdl



Power Module 1 (PM1)

=====

>>> Input Information; PCB input:(J6/pins 1 - 6)
 Pin Label On Message Off Message

 There are 6 of 6 currently unused Inputs

>>> Load Information

PM1 Load 1 (PM1L1); PCB output: (J1/OUT1)
 Load Type: N O T U S E D

PM1 Load 2 (CBPwr); PCB output: (J1/OUT2)

 Load Type: Standard

 Over Current: 25 amps

 Under Current: 0 amps ---> UC Load Shut Off: NO

 Load LED1: ISP Switch 2

 Load LED2: None

 ON Msg: CB Pwr ON

 OFF Msg: CB Pwr OFF

 Load Activated when:

 ISP Switch 2 = On

 ConditionSet: CBpwr

PM1 Load 3 (EmerFlsh); PCB output: (J2/OUT3)

 Load Type: Delay OFF (Flashing)

 Load ON Time: 0.1 sec

 Load OFF Time: 0.1 sec

 Timing Period: 10 sec

 Over Current: 15 amps

 Under Current: 0 amps ---> UC Load Shut Off: NO

 Load LED1: None

 Load LED2: None

 ON Msg:

 OFF Msg:

 Load Activated when:

 LiftDr = On

 ConditionSet: EmerLite

 - and LiftOut = On

PM1 Load 4 (PM1L4); PCB output: (J2/OUT4)

 Load Type: N O T U S E D



```
# PM1 Load 5 (IntLite);      PCB output: (J9/OUT5)

  Load Type:  Standard

  Over Current: 15 amps
  Under Current: 2 amps ----> UC Load Shut Off: YES

  Load LED1: None
  Load LED2: None
  ON  Msg:
  OFF Msg:

  Load Activated when:
      ISP Switch 1 = On                ConditionSet: IntLite

# PM1 Load 6A (LoHeat);      PCB output: (J9/OUT6A)

  Load Type:  Standard

  Over Current: 15 amps
  Under Current: 0 amps ----> UC Load Shut Off: NO

  Load LED1: None
  Load LED2: None
  ON  Msg:
  OFF Msg:

  Load Activated when:
      ISP Switch 5 = On                ConditionSet: Heater Low

# PM1 Load 6B (HiHeat);      PCB output: (J9/OUT6B)

  Load Type:  Standard

  Over Current: 15 amps
  Under Current: 0 amps ----> UC Load Shut Off: NO

  Load LED1: None
  Load LED2: None
  ON  Msg:
  OFF Msg:

  Load Activated when:
      ISP Switch 5 = On 2              ConditionSet: Heater High

# PM1 Load 7 (PM1L7);      PCB output: (J8/OUT7)
  Load Type:  N O T   U S E D
```



```
# PM1 Load 8 (PM1L8);      PCB output: (J8/OUT8)
  Load Type:  N O T   U S E D

# PM1 LCO 1 ();      PCB output: (J17/PIN4)
  Load Type:  N O T   U S E D

# PM1 LCO 2 ();      PCB output: (J17/PIN3)
  Load Type:  N O T   U S E D

# PM1 LCO 3 ();      PCB output: (J17/PIN2)
  Load Type:  N O T   U S E D

# PM1 LCO 4 ();      PCB output: (J17/PIN1)
  Load Type:  N O T   U S E D
```

Door Module 1 (DM1)

=====

```
>>> Input Information;      PCB input:(J4/pins 1 - 6)
  Pin Label      On Message      Off Message
```

There are 6 of 6 currently unused Inputs

```
>>> Load Information
```

```
# DM1 Load 1 (DoorOpen);    PCB output: (J1/OUT1)

  Load Type:  Standard

  Over Current: 10 amps
  Under Current: 0 amps ---> UC Load Shut Off: NO

  Load LED1: None
  Load LED2: None
  ON  Msg:
  OFF Msg:

  Load Activated when:
    Door Open Switch = On      ConditionSet: DrOPEN
  - and Transmission Range = Park
```

```
# DM1 Load 2 (DoorClos);    PCB output: (J1/OUT2)

  Load Type:  Standard
```



Over Current: 10 amps
Under Current: 0 amps ---> UC Load Shut Off: NO

Load LED1: None
Load LED2: None
ON Msg:
OFF Msg:
Limit Switches : YES
Remote Entry : YES

Load Activated when:
Door Close Switch = On ConditionSet: DrClose

DM1 Load 3 (DM1L3); PCB output: (J2/OUT3)
Load Type: N O T U S E D

DM1 Load 4 (DM1L4); PCB output: (J2/OUT4)
Load Type: N O T U S E D

DM1 LCO 1 (); PCB output: (J17/PIN4)
Load Type: N O T U S E D

DM1 LCO 2 (); PCB output: (J17/PIN3)
Load Type: N O T U S E D

DM1 LCO 3 (); PCB output: (J17/PIN2)
Load Type: N O T U S E D

DM1 LCO 4 (); PCB output: (J17/PIN1)
Load Type: N O T U S E D

**** S Y S T E M L O A D S H E D D I N G ****

Initiation Voltage: 10.5 Volts
Time Between Sheds: 10 Seconds

Shed Sequence:
First > CBPwr
Second > IntLite
Third > HiHeat
Fourth > LoHeat



**** S Y S T E M W A R N I N G S ****

WARNING # 1 (Warn 1)

LED Type: Flash

Buzzer Type: Tone 3

Line 1: BACK DOOR

Line 2: OPEN

Activate Warning if:

 LiftDr = On

 ConditionSet: WrnDr

 - and Transmission Range = !Park



7 REFERENCES

7.1 InterMotive Vehicle Controls

986 S. Canyon Way
Colfax, CA 95713
www.intermotive.net
Phone: (530) 346-1801
Fax: (530) 346-1812