

Guardian Personal Mobility Lift Interlock GRD601-BB

Installation Instructions

Application

**Chevy/GMC Full Size Van (GMT 610) – 2008
All V8 Engines except Flex Fuel**

GUARDIAN MODULE - Remove the lower dash panel below the steering column. The Guardian Module should be positioned in a secure area below the steering column. It can be secured using self tapping screws, adhesive foam tape, or wire ties. Do not secure the module until all harnesses are installed and proper lift operation has been verified.

LED DISPLAY PANEL – This harness can be identified by the blue tape near the 6-pin connector. Locate a suitable position on the dashboard, within view of the driver for the mounting of the LED Display Panel. The length of the display harness is 40". This is the maximum distance the display can be from the Guardian module. Drill a $\frac{3}{4}$ " hole in the dashboard where you wish the center of the display to be. Snap the blue taped end of the LED display harness into the Guardian Module in the connector labeled in blue "Display". Run the other end of the harness under the dash and out through the $\frac{3}{4}$ " hole. Snap the end of the display harness into the LED Display Panel. Ensure panel is level, and secure using the supplied screws.



(FIG. 1)



LIFT HARNESS – This harness can be identified by the green tape near the 6-pin connector. Attach the appropriate wheelchair lift adapter to the lift harness, then attach adapter to the wheelchair lift. Run the lift harness from the wheelchair lift to the Guardian Module (Foot-well and drivers kick panel trim may be removed for harness routing). Finally, snap the green taped end of the Lift Harness into the Guardian connector labeled in green “Lift”.



Before continuing installation, the following check must be performed:

Verify that the vehicle ignition is off and the lift is fully stowed for at least 5 minutes. This will ensure the Guardian module is in sleep mode. Attempt to deploy the wheelchair lift. Both the red and green indicators on the LED Display Panel should briefly illuminate as a prove-out after the module wakes up. If they do not, check to make sure each harness is connected to the proper Guardian Module connector as outlined in the above steps. Only proceed to the next step if the indicators illuminate. Otherwise, damage can occur to the module.

Black 4- Pin Connector - Located on the right side of the park brake and inline with service brake on/off switch (Fig. 2). Separate Black 4-pin OEM connector and install matching InterMotive T-harness.

(Fig. 2)

Shift Lock Solenoid- Locate OEM shift lock solenoid and remove OEM 2-pin black connector and install matching InterMotive T- harness (Fig. 3). Verify Green locking tab is in the locked position.

(Fig. 3)

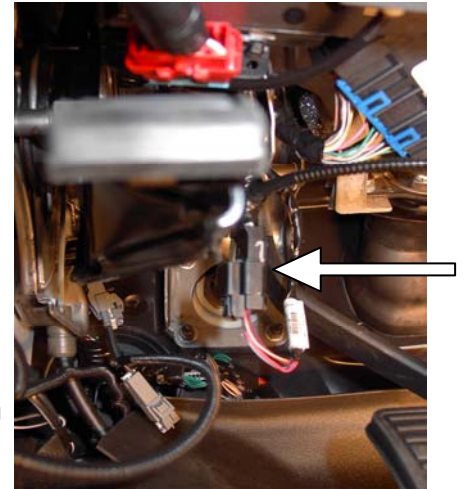

Gray 2-Pin Connector (ParkBrake)

Located forward of the drivers kick panel. Separate the 2-pin OEM connector and install the matching InterMotive T- harness (Fig. 4).

(Fig. 4)

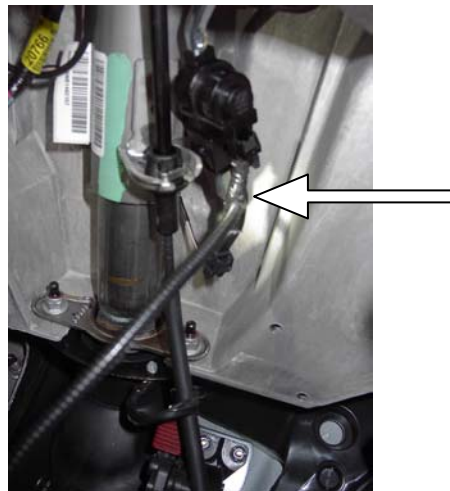
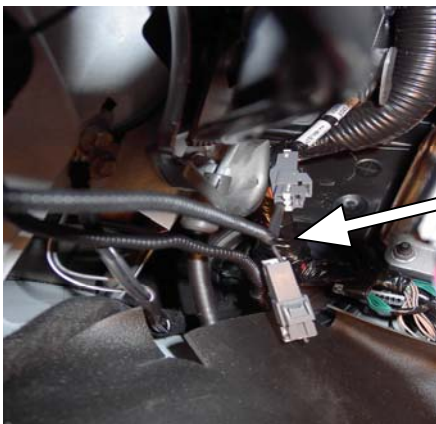

DATA LINK HARNESS – Locate the vehicle Data Link Connector. It will be mounted next to the park brake release (FIG. 5). Remove the 2 mounting screws for the Data Link. Ensure the connection is fully seated and secure with the supplied wire tie. Mount the black connector from the Guardian Data Link Harness where the vehicle Data Link Connector originally was. Secure the Data Link Harness such that it does not hang below the lower dash panel.



(FIG. 5)

CAN Module - Attached to the Guardian wire harness, the CAN Module only requires a secure mounting and must not be removed from harness (FIG. 6).



(FIG. 6)



Finally, plug the orange taped 6-pin connector into the Guardian Module in the connector labeled in orange “Vehicle 1” and plug the 4-pin connector into the connector labeled in white “Vehicle 2”.

Secure the Guardian Module in its final location and test for proper operation. (See Post Installation Check List).



An ISO 9001:2000 Registered Company

Guardian Personal Mobility Lift Interlock GRD601-BB

Post Installation Check List

The following checks must be made after installation of the InterMotive Guardian GRD501 or GRD601 to ensure correct and safe operation of the lift. If any of the checks do not pass, do not deliver the vehicle. Recheck all connections as per the installation instructions.

Begin the checklist with the vehicle in the following state:

- Lift stowed
 - Park brake set
 - Transmission in park
 - Ignition off
 - All Guardian LED's not illuminated (sleep mode)
 - Lift access door open
1. Turn on the ignition. Verify that all LED's prove out and green lift power LED remains illuminated.
 2. Release the park brake. The green LED for lift power should now be off. Attempt to deploy the lift. The lift must not deploy.
 3. Set the park brake and shift the transmission out of park. The green LED for lift power should now be off. Attempt to deploy the lift. The lift must not deploy.
 4. Place the transmission in park. The green LED for lift power should now be illuminated.
 5. Attempt to deploy the lift. The lift should deploy and the red LED for lift-not-stowed should illuminate.
 6. With the lift deployed, attempt to shift the transmission out of park. The transmission shift lever must not be able to shift.
 7. Stow the lift. The red LED for lift-not-stowed should now be off.
 8. Turn off ignition.
 9. Wait approximately 5 minutes for the module to enter "sleep mode." This is verified when all LED's (including backlit icons) turn off.
 10. Attempt to deploy the lift. The module should prove-out all LED's and the lift should deploy.
 11. Stow the lift. Installation is complete.



An ISO 9001:2000 Registered Company

Guardian Personal Mobility Lift Interlock GRD601-BB Operating Instructions

The Guardian is a microprocessor driven system for controlling wheelchair lift operation. Lift operation will only be allowed when all of the following conditions are met:

1. The vehicle is in "Park"
2. The parking brake is applied.
3. The lift deploy switch is activated

The Guardian also will not allow the vehicle to be shifted out of park if the lift is not stowed.

The Guardian will operate with the vehicle ignition on or off. When the ignition is turned on or the lift deploy switch is activated, the LED panel will prove out by illuminating the red and green indicators briefly. When the wheelchair lift is stowed and ignition power is not present for 5 minutes, the Guardian will enter a low current "sleep" mode of operation. To wake up from "sleep" mode, the ignition must be turned on or the lift deploy switch must be activated. After prove out, the operation of the indicators is as follows:

- Lift Power – Illuminates in green if power is available to the lift. This means that all conditions for lift operation have been met.
- Lift Not Stowed – Illuminates in red when the wheelchair lift is not stowed. If illuminated, the driver will not be allowed to shift out of park.

The indicators can also be used for diagnostic purposes. For example, if the Lift Not Stowed icon is illuminated when the lift is stowed, the driver will not be able to shift out of park. This means that the Guardian detects that the lift is not stowed. Thus, a technician should inspect the lift stowed switch and its circuit for proper operation.

REVISIONS

DATE :	CHANGE :
--------	----------

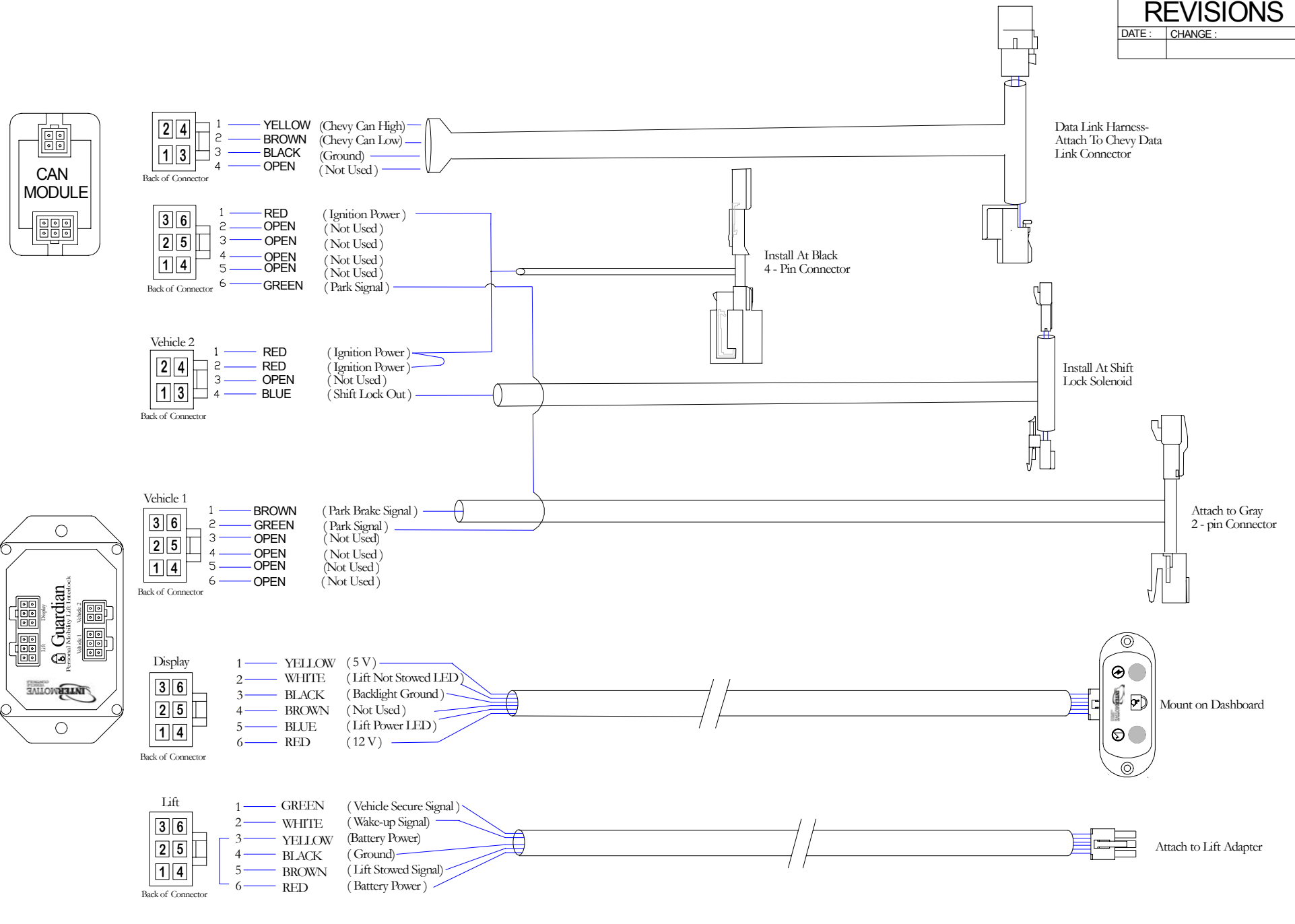
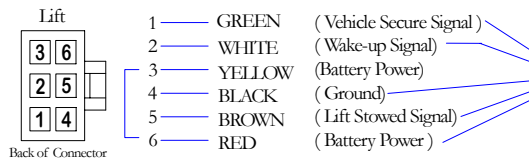
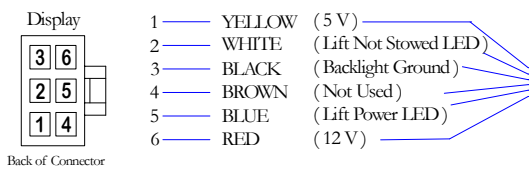
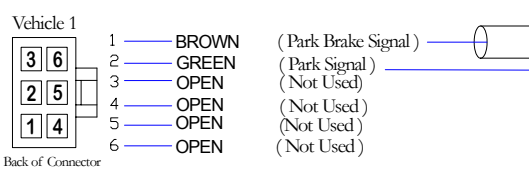
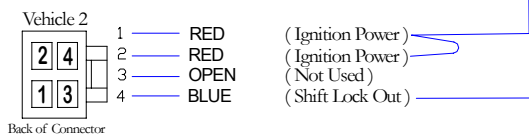
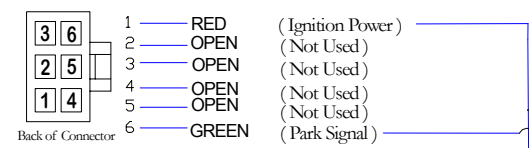
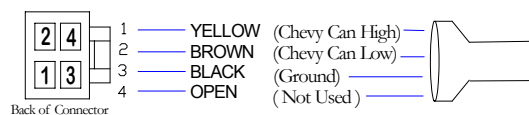
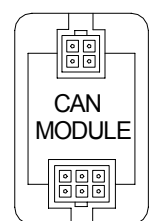

PRODUCT: **Chevy Guardian**

DRAWN BY:	Bruce Hodge	PART NO.:	GRD601-B
DATE DRAWN:	10/11/07	CHECK BY:	Ed Prokopik
		DATE CHECKED:	11/1/07

REVISIONS

DATE: CHANGE:

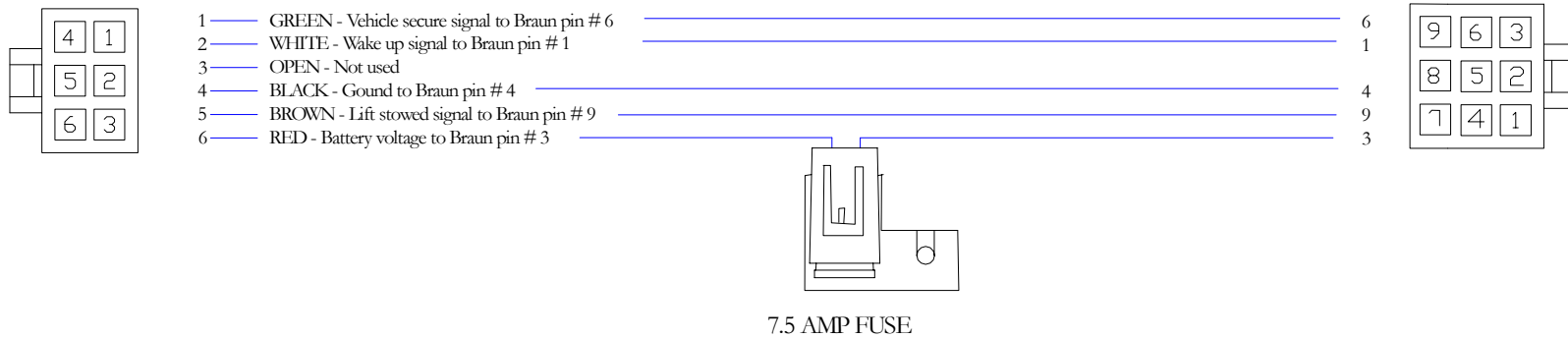

PRODUCT:

Braun Personal Lift Adapter

DRAWN BY:

Bruce Hodge

PART NO:

GRD1- AB

DATE DRAWN: 11/23/05

CHECK BY:

Ed Prokopik

DATE CHECKED: