

Aftermarket Interface Module™ AIM516-B (2015-2018 Ford Transit)



Introduction

The AIM516 provides three major functions to facilitate the production of emergency vehicles. A fast idle feature that triggers from a number of configurable sources including battery voltage, parking brake and a discrete input. It provides 8 outputs which can be configured to turn on in response to a variety of vehicle data. These outputs are used to drive various external loads. It provides a vehicle interlock that prevents the driver from shifting out of park if certain conditions are not met.

Installation Instructions

Disconnect the battery before proceeding with the installation.



WARNING
Disconnect the battery to prevent setting a check engine light.

It is the installer's responsibility to route and secure all wiring harnesses where they cannot be damaged by sharp objects, mechanical moving parts and high heat sources. Failure to do so could result in damage to the system or vehicle and create possible safety concerns for the operator and passengers.

It is important to avoid placing the module where it could encounter strong magnetic fields from high current cabling connected to motors, solenoids, etc. Also avoid radio frequency energy from antenna's or inverters next to the module. Finally, avoid high voltage spikes in vehicle wiring by always using diode clamped relays when installing upfitter circuits.

AIM516 Module

Remove the lower dash panel below the steering column and find a suitable location to mount the AIM516 module. Do not mount the module where it will be exposed to excessive heat. Do not mount the module until all wire harnesses are routed and secure. The last step of the installation is to mount the module.

Data Link Harness (6-pin connector)

1. Locate the vehicle's OBDII Data Link Connector, mounted below the lower left dash panel.
2. Remove the mounting screws for the OBDII connector. Plug the Red connector from the AIM516 Data Link Harness into the vehicle's OBDII connector. Ensure the connection is fully seated and secure with the supplied wire tie.
3. Mount the pass through connector from the AIM516 Data Link Harness in the former location of the vehicle's OBDII connector.
4. Secure the AIM Data Link harness so that it does not hang below the lower dash panel.



Installation Instructions (continued)

Fast Idle

The fast idle system controls engine idle RPM in response to a number of triggers in order to increase electrical and mechanical output of the vehicle. By default, gas engines idle at 1500 RPM while diesel engines idle at 1200 RPM.

Fast Idle Engage Input (4-Pin Connector)

Attach the AIM516 Harness connector Pin #1 Green/White wire on the 4 pin connector to any equipment that provides a ground signal when the fast idle needs to be engaged. (PTO, pump, etc....)

Fast Idle Triggers		
Trigger Name	Trigger Conditions	Disable Conditions
Manual Engage Input	Fast Idle Engage Input wire activated	Fast Idle Engage Input wires not active
VBAT Low (if enabled)	VBAT < 12.5V (default)	VBAT > 13.5V for > 5 minutes (default)
Parking Brake (if enabled)	Parking Brake applied	Parking Brake Released

Fast Idle Preconditions

The following preconditions must be met prior to initiating Fast Idle operation:

- Vehicle speed zero
- Transmission in Park
- Accelerator pedal not applied
- Engine Coolant temperature less than 230°F
- Engine RPM must be greater than 200 and less than 2800
- Service Brake not applied
- Parking Brake must be applied if this feature is enabled

Pin Mode— AIM Application

Outputs can be configured from the factory for various modes, as described below. Momentary mode is the most commonly used, where an output is 'active' only when the proper conditions have been met.

Momentary: Output follows condition set but with a turn on delay, and a turn off delay. Setting 'On Delay' and 'Off Delay' to zero causes the output pin to simply "follow" the condition set being true (ON) and false (OFF).

Pin Mode	Momentary	Off Delay (s)	0	On Delay (s)	0
----------	-----------	---------------	---	--------------	---

Latching: This mode will latch an output pin ON, starting 'On Delay' seconds after the conditions are met, and will keep it ON even after the conditions are no longer true. It will then latch the output OFF, following 'Off Delay' seconds after the conditions are met again. Think of it as toggle on—toggle off. The simplest use would be when using a momentary button as the only input condition and setting the Delays to zero. Thus a load could be turned on by pushing a momentary button, and turned back off by pushing the button a second time.

Pin Mode	Latching	Off Delay (s)	0	On Delay (s)	0
----------	----------	---------------	---	--------------	---

Time Hold: The output pin goes ON after the conditions become true, and stays ON for the selected 'On Time', regardless of the conditions. Off Time is Not Applicable.

Pin Mode	Time Hold	Off Time (s)		On Time (s)	0
----------	-----------	--------------	--	-------------	---

Time Delay: Output is turned ON after the selected 'delay' time after the conditions are met. It stays on for selected 'On time', regardless of input conditions.

Pin Mode	Time Delay	Delay (s)	0	On Time (s)	0
----------	------------	-----------	---	-------------	---

Flashing—Momentary: Used for creating a flashing output. When conditions are met, output flashes. When conditions are no longer met, flashing stops. Flashing ON and OFF times (duty cycle) are controlled by entering the following values.

Pin Mode	Flashing - Momentary	Off Time (.1s)	0	On Time (.1s)	0
----------	----------------------	----------------	---	---------------	---

Flashing - Latching: Same as above, except flashing will continue after conditions are no longer true, and will stop when conditions become true again—toggle ON, toggle OFF. Duty cycle is controlled by the ON and OFF times.

Pin Mode	Flashing - Latching	Off Time (.1s)	0	On Time (.1s)	0
----------	---------------------	----------------	---	---------------	---

AIM516 Output pin-out definition

Outputs 2 through 8 are configurable by Intermotive as either active high (12V) or active low (ground). Each of these outputs are rated at 1/2A and are intended to drive relay coils or other low current loads. Output 1 is a high current (8A max.) output and should be fused. The output sense for Output 1 (Pin #2 Purple wire on the 4 pin connector) depends on the input at Pin #4 (Tan wire) on the 4 pin connector (i.e., 12V on Pin #4 will output 12V on Pin #2 when Output 1 is active).

The 8 outputs are defined as follows:

- Pin #1 N/C
 - Pin #2 (Green wire) Output 2
 - Pin #3 (White wire) Output 3
 - Pin #4 (Gray wire) Output 4
 - Pin #5 N/C
 - Pin #6 N/C
 - Pin #7 N/C
 - Pin #8 (Brown wire) Output 5
 - Pin #9 (Orange wire) Output 6
 - Pin #10 (Blue wire) Output 7
 - Pin #11 (Yellow wire) Output 8
 - Pin #12 N/C
-
- Pin #1 (Green/White Wire) General Purpose Input 1
 - Pin #2 (Purple) Output 1
 - Pin #3 Shift Lock Input or General Purpose Input 2 (Optional)
 - Pin #4 (Tan wire) Output 1 Source

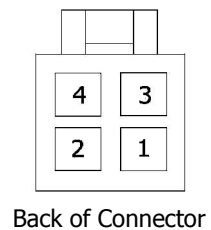
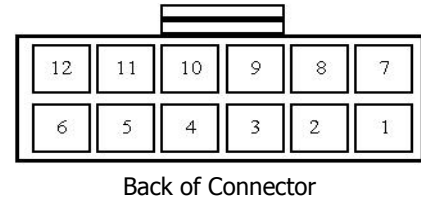

Connect the desired outputs to vehicle equipment as needed. Tape up unused leads. When connecting to relays, use relays with appropriate kick-back suppression, such as Digikey #PB682-ND. Unsuppressed relays will induce very high voltage spikes throughout modern vehicle's sensitive computer electronics and should not be used, per Ford, GM, SAE, etc.

By default, all outputs are active low and configured as follows:

- Output #1 (Purple wire) Engine Cranking
- Output #2 (Green wire) TR = Park
- Output #3 (White wire) Parking Brake Applied
- Output #4 (Gray wire) TR = Reverse
- Output #5 (Brown wire) Ignition On
- Output #6 (Orange wire) Engine Running
- Output #7 (Blue wire) Right Turn Signal On
- Output #8 (Yellow wire) Left Turn Signal On

Interlock (optional)

To prevent the vehicle from shifting out of park in certain scenarios, the AIM516 can lock the shifter on command. This feature is optional and must be enabled to function.

Shift Lock Triggers		
Trigger Name	Trigger Conditions	Disable Conditions
External Input	Shift lock Input wire activated (Ground signal on pin 3 Pink wire on the 4 pin connector)	Shift lock Input wire not active
Cruise Control On	Pressing the "Accelerator" button on the steering wheel while in Park and the Ignition is On	Pressing the "Decelerator" button while the Ignition is On

Door Unlock

Locate BCM connector C2280C under the steering column and tap into Pin56 (Violet/Grey) wire. Momentarily (greater than half a second) applying a ground signal to that wire causes all doors to Unlock.

Reconnect the vehicle battery

During VIN acquisition: Scrolling LED's between LED1 and LED5 indicate an error occurred while acquiring the VIN.

Verify that the chassis is supported by this product. If work was recently performed on this chassis, the VIN may have been cleared in the PCM.

A lit LED between LED 1 and LED 5 will indicate the following:

LED 1	Manufacturer Error
LED2	Model Error
LED3	Engine Error
LED4	Model Year Error
LED5	VIN Error

Post Installation System Operation Test

Perform the following tests before actually mounting the module, to allow easy viewing of the diagnostic LED's, if needed.

1. Place transmission in Park and start the engine. **Note:** Vehicle may enter Fast Idle if VBAT is low. Either wait to see if the battery charges and Fast Idle stops, or place a charger on the vehicle to disable the VBAT low trigger to allow testing of other triggers.
2. Manually engage the Fast Idle Input by having aftermarket vehicle equipment ground the Input wire. Engine speed will increase to the set RPM level. If this does not occur, check harness connections. Also see diagnostics below.
3. When Fast Idle is engaged, keep the Input wire grounded, and depress the Service Brake for 1 second. Fast idle will temporarily disengage anytime the Service Brake is pressed, and will automatically reengage after approximately 2 seconds once the Brake pedal is released.
4. Place transmission shift lever in the "Neutral" position. (Input wire still grounded). Verify the vehicle does not go into Fast Idle.
5. Verify outputs 1-8 are working correctly.
6. If the optional Interlock feature is enabled, press the cruise control button while in Park and verify that the vehicle cannot be shifted out of Park. Press the cruise control button again and confirm that the vehicle can now be shifted out of Park. Supply a ground signal on pin 1 Green/White wire on the 4 pin connector) and verify that the vehicle cannot be shifted out of Park. Remove the ground signal and confirm that the vehicle can now be shifted out of Park.

If the AIM516 fails any of the above tests, check harnesses and review instructions, or check diagnostics below. If necessary, call InterMotive Technical Support at (530) 823-1048.

Post Installation System Operation Test (continued)

Diagnostics

Diagnostic mode is entered by momentarily grounding the mounting pad labeled "Test" on the module. This can be done with a simple jumper wire by holding one end to chassis ground, while touching the other end to the "Test" pad. The module provides diagnostic LEDs which illuminate according to the following table. To exit this mode simply cycle the key or momentarily ground the "Test" pad again.

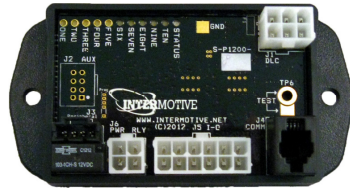

LED #	Diagnostic Mode LED Descriptions
1	Output 1 is On
2	Output 2 is On
3	Output 3 is On
4	Output 4 is On
5	Output 5 is On
6	Output 6 is On
7	Output 7 is On
8	Output 8 is On
9	Fast Idle Input Active
10	Door Unlock Input Active
STATUS	Continuously flashes two digit status codes. See Status Code table

Fast Idle Status Codes

Status Codes provide the current status of the Fast Idle system. The on-board "Status" LED will flash a 2-digit code as shown in the table. The first digit will flash, wait one second, flash the second digit, then wait four seconds before the next code. The Status Codes continue to flash until the module is reset (cycle key), or the test input is momentarily grounded again.

AFIS Status Codes	
Status Code	Description
1-1	Ready for fast idle
2-3	Triggered: Parking Brake
2-4	Triggered: VBAT Low
2-8	Triggered: Engage Input
3-1	RPM > 2800
3-2	RPM < 200
3-3	TR not = to PARK
3-4	VSS not = to 0 MPH
3-5	Service Brake applied
3-6	TFT > 250
3-7	Need to cycle TR
3-8	ECT > 230°F
3-9	Need to Apply PB
3-10	No Security Access

AIM 516 Module Mounting

Ensure all harness are properly connected and routed, and are not hanging below the dash area. Mount the AIM516 module using screws or double sided tape. Reinstall the lower dash panel.



An ISO 9001:2008 Registered Company

LEAVE IN VEHICLE Operating Instructions - Aftermarket Interface Module™ AIM516-B (2015-2018 Ford Transit)

System Operation

The AIM516 provides three major functions to facilitate the production of emergency vehicles. It provides a fast idle feature that triggers from a number of configurable sources including battery voltage, parking brake and a discrete input. It provides 8 outputs which can be configured to turn on in response to a variety of vehicle data. These outputs are used to drive various external loads. It provides a vehicle interlock that prevents the driver from shifting out of park if certain conditions are not met.

Fast Idle

The fast idle system controls engine idle RPM in response to a number of triggers in order to increase electrical and mechanical output of the vehicle. By default, gas engines idle at 1500 RPM while diesel engines idle at 1200 RPM.

Fast Idle Triggers		
Trigger Name	Trigger Conditions	Disable Conditions
Manual Engage Input #1	Fast Idle Engage Input wire activated	Fast Idle Engage Input wires not active
VBAT Low (if enabled)	VBAT < 12.5V (default)	VBAT > 13.5V for > 5 minutes (default)
Parking Brake (if enabled)	Parking Brake applied	Parking Brake Released

Fast Idle Preconditions

The following preconditions must be met prior to initiating Fast Idle operation:

- Vehicle speed zero
- Transmission in Park
- Accelerator pedal must not be applied
- Engine Coolant temperature less than 230°F
- Engine RPM must be greater than 200 and less than 2800
- Service Brake not applied
- Parking Brake must be applied if this feature is enabled

Operating Instructions (continued)

Door Unlock

Locate BCM connector C2280C under the steering column and tap into Pin56 (Violet/Grey) wire. Momentarily (greater than half a second) applying a ground signal to that wire causes all doors to Unlock.

Interlock (optional)

To prevent the vehicle from shifting out of park in certain scenarios, the AIM516 can lock the shifter on command. This feature is optional and must be enabled to function.

Shift Lock Triggers		
Trigger Name	Trigger Conditions	Disable Conditions
External Input	Shift lock Input wire activated (Ground signal on pin 3 Pink wire on the 4 pin connector)	Shift lock Input wire not active
Cruise Control On	Pressing the "Accelerator" button on the steering wheel while in Park and the Ignition is On	Pressing the "Decelerator" button while the Ignition is On

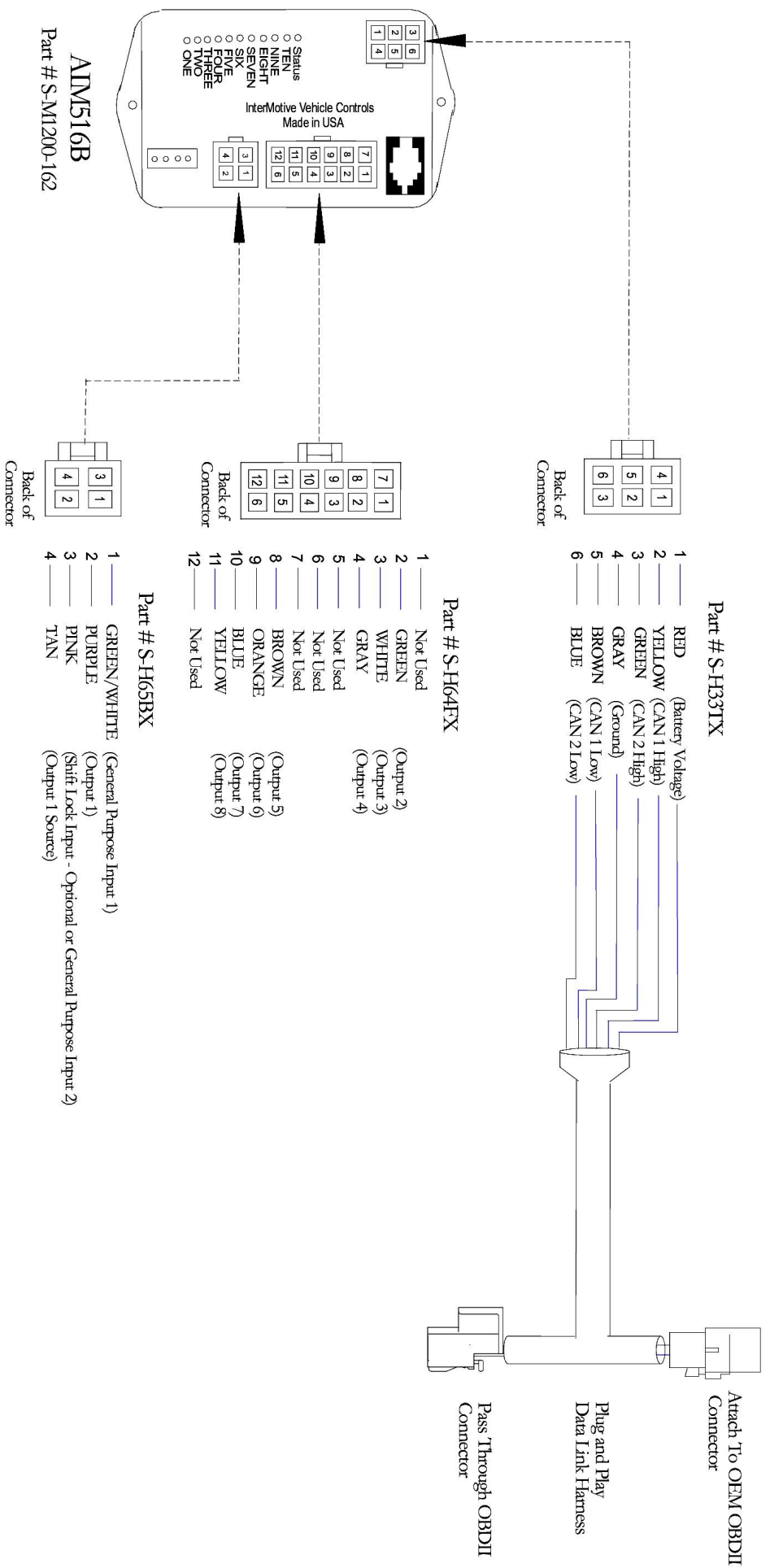

If the AIM516 fails any step in the Post Installation Test, review the installation instructions and the loaded configuration by running the Graphical User Interface application. If necessary, call InterMotive technical support at (530) 823-1048.

Submit product registration at www.intermotive.net